



Physikalisch-Technische Bundesanstalt

CIPM Key Comparison

CCL-K5

CMM 1D: Step Gauge and Ball Bars

Final Report

V3.2

Otto Jusko, PTB, Braunschweig, September 2009

1 Introduction	3
2 Organisation.....	3
2.2 Participants	3
2.3 Schedule	6
3 Standards	7
3.1 Ball Bars.....	7
3.2 Step Gauge	8
3.3 Transport Damage	9
4 Measurement instructions and reporting of the results	10
4.1 Traceability	10
4.2 Measurands	10
4.3 Inspection of the artefacts	10
4.4 Alignment	10
4.5 Expansion Correction.....	11
4.6 Reporting of incomplete data	11
4.7 Measurement Uncertainty	11
5 Stability and condition of the Artefacts	11
5.1 Step Gauge Stability	11
5.1 Ball Bar Stability	12
6 Measurement results, as reported by participants	13
6.1 Step gauge data.....	13
6.2 Ball bar data	14
7 Measurement uncertainties	15
7.1 Step gauge data uncertainty	15
7.2 Ball bar data uncertainty	16
8 Analysis of the reported results	16
8.1 Reference values for Step Gauge: NMIJ-METAS-NIST-PTB Mean Reference.....	16
8.2 Step gauge deviations from reference value and uncertainty of deviations	16
8.3 Reference values for ball bar data	25
8.4 Ball bar deviations from reference values.....	25
8.5 Definition of En	27
8.6 En – values	27
9 Conclusions	29
9.1 Step gauge data.....	29
9.2 Ball bar data	29
9.3 Measurement procedures and uncertainty budgets	29
10 References	29
Appendix A: Determination of the Key Comparison Reference values	30
Appendix B: Step gauge data analysed using constant and proportional components.....	31
Appendix C: Ball bar data for the KCDB.....	35

1 Introduction

The metrological equivalence of national measurement standards and of calibration certificates issued by national metrology institutes is established by a set of key comparisons chosen and organized by the Consultative Committees of the CIPM or by the regional metrology organizations in collaboration with the Consultative Committees.

At its meeting in September 1997, the Consultative Committee for Length, CCL, decided upon a key comparison on CMM 1D artifacts, numbered CCL-K5, starting in Spring 1999, with the Physikalisch-Technische Bundesanstalt (PTB) as the pilot laboratory.

The results of this international comparison contribute to the Mutual Recognition Arrangement (MRA) between the national metrology institutes of the Metre Convention. This CIPM key comparison is linked with regional comparisons (RMO key comparisons) following exactly the same scheme. Laboratories participating in both the CIPM and the RMO comparisons establish the link between these comparisons and assure their equivalence.

2 Organisation

The technical protocol was drafted by PTB with the help of contributions from other participants. The protocol document and this report have been based on the corresponding documents for key comparison CCL-K1, CCL-K2, and EUROMET-372. The protocol document was issued to all participants at the start of the comparison.

2.2 Participants

All members of the CCL were invited to participate, subject to meeting certain technical requirements as laid out in the draft protocol document. In order to further reduce the number of participants to an acceptable level, each RMO was asked to limit the number of participants in their region, by its own decision process. The list of participants as originally printed in the protocol is given in Table 1.

Contact Person	National Metrology Institute and address	Tel. / Fax / e-mail:
Alexandr N. Korolev	VNIIM Gosstandart of Russia D.I. Mendeleev Institute for Metrology 19, perspective de Moskovsky 198005 St. Petersburg Russia	Tel. +7 812 251 8638 Fax. +7 812 113 0114 e-mail: al_korolev@mail.ru
Edgar Arizmendi Reyes	CENAM Laboratorio de Máquina de Medición por Coordenadas Laboratorio de Ángulo Carretera a los Cués km 4,5 El Marques Querétaro 76900 Mexico	Tel. +52 42 11 05 00 – 3282 Fax +52 42 11 05 77 e-mail: earizmen@cenam.mx

Steven Phillips	<p>NIST</p> <p>National Institute of Standards and Technology</p> <p>Precision Engineering Division Metrology Bldg. (220), R. A105 MET B113</p> <p>Gaithersburg, MD 20899</p> <p>USA</p>	<p>Tel. +1-301-975-3565</p> <p>Fax -</p> <p>e-mail: Steven.Phillips@nist.gov</p>
Kostadin Doytchinov	<p>NRC</p> <p>Institute for National Measurement Standards</p> <p>National Research Council Canada Montreal Rd. M-36</p> <p>Ottawa, K1A 0R6</p> <p>Canada</p>	<p>Tel. +1-613-991-0265</p> <p>Fax +1-613-952-1394</p> <p>E-MAIL: kostadin.doytchinov@nrc.ca</p>
Nicholas Brown	<p>CSIRO</p> <p>Division of Telecommunications and Industrial Physics</p> <p>National Measurement Laboratory</p> <p>Bradfield Rd. West Lindfield NSW 2070</p> <p>Australia</p>	<p>Tel. +612-9413-7157</p> <p>Fax +612-9413-7474</p> <p>e-mail: nick.brown@tip.csiro.au</p>
John. R. Hannaford	<p>CSIR</p> <p>National Metrology Laboratory CSIR Building 5</p> <p>Meiring Naude Rd. Brummeria Pretoria 0001</p> <p>Republic of South Africa</p>	<p>Tel. +27-12-841-4799</p> <p>Fax +27-12-841-4458</p> <p>e-mail: jrhanaf@csir.co.za</p>
Dr. Cheon Il Eom	<p>KRISS</p> <p>Korea Research Institute of Standards and Science P.O. Box 102, Yusong Taejon, 305-600</p> <p>South Korea</p>	<p>Tel. +82-42-868-5103</p> <p>Fax +82-42-868-5444</p> <p>e-mail: cieom@kriss.re.kr.</p>

Shen Shaoxi	NIM No. 18, Bei San Huan Dong Lu Beijing 100013 China	Tel. +86 10 6422 6657 Fax +86 10 6421 8703 e-mail: shenshaoxi@ihw.com.cn
Tomizo Kurosawa	NMIJ / AIST Lengths and Dimensions Division, National Metrology Institute of Ja- pan (NMIJ) National Institute of Advanced In- dustrial Science and Technology (AIST) 1-1-1 Umezono Tsukuba, Ibaraka 305-8563 Japan	Tel. +81-298-61-4041 Fax +81-298-61-4042 e-mail: tomizo.kurosawa@aist.go.jp
Emilio Prieto	CEM Centro Español de Metrologia C/del Alfar, 2 28760 Tres Cantos Spain	Tel. +34-91 8074 716 Fax +34-91 8074 807 email: eprieto@mfom.es
Attilio Sacconi	IMGC Istituto di Metrologia Gustavo Co- lonnetti Strada delle Cacce 73 I-10135 TORINO Italy	Tel. +39-011-3977-466 Fax +39-011-3977-459 email: A.sacconi@imgc.to.cnr.it
Rudolf Thalmann	METAS Swiss Federal Office of Metrology and Accreditation Lindenweg 50 CH-3003 Bern - Wabern Switzerland	Tel. +41-31 323 33 85 Fax +41-31 323 3210 email: Rudolf.thalmann@metas.admin.ch

Coordinator:

Otto Jusko	PTB Physikalisch-Technische Bundes- anstalt Bundesallee 100 D-38116 Braunschweig Germany	Tel. +49-531-592-5301 Fax +49-531-592-5305 e-mail: otto.jusko@ptb.de
------------	---	--

2.3 Schedule

Between 1999 and 2001 the comparison ran according to schedule with the exception of the skip of VNIIM. In the beginning to 2001 it was tried to include VNIIM as last participant. But because of customs problems to that time they withdrew at last. Also IMGC withdrew during the comparison. Because of technical problems NRC and CSIR did not report any data.

At the September meeting of CCL-WGDM in 2001 a re-measure was granted for those who asked for it (NRC, CSIR, CENAM). Only CENAM realised a re-measure in 2002.

Region	NMI	Country	Date
NORAMET-1	CENAM	Mexico	4-1999
	NIST	USA	5-1999
	NRC	Canada	6-1999
1st return to pilot laboratory	PTB	Germany	8-1999
SADCMET	CSIR	South Africa	10-1999
APMP	CSIRO	Australia	11-1999
	NMIJ	Japan	12-1999
	KRISS	South Korea	2-2000
	NIM	China	4-2000
2nd return to pilot laboratory	PTB	Germany	6-2000
COOMET	VNIIM	Russia	8-2000
EUROMET	CEM	Spain	9-2000
	METAS	Switzerland	10-2000
	IMGC	Italy	11-2000
NORAMET-2	CENAM	Mexico	3-2002

Table 1 : Participant list and schedule

3 Standards

Three ball bars and a step gauge were chosen as calibration artifacts. They were supplied in two large wooden boxes containing additional individual packing boxes.

3.1 Ball Bars

Three ball bars were donated by NIST, two of them made from steel, one made from Super Invar, so the influence of thermal expansion could be examined. The ball bars were packed in individual transport containers which were send around inside a large wooden box.

ball bar #1

455 Custom Stainless Steel, nominal length 400 mm center-to-center (Serial-# UHP-455-SS-04), thermal expansion coefficient $\alpha = 10.33 \times 10^{-6} \text{ K}^{-1}$

ball bar #2:

455 Custom Stainless Steel, nominal length 800 mm center-to-center (Serial-# UHP-455-SS-09) , thermal expansion coefficient $\alpha = 10.34 \times 10^{-6} \text{ K}^{-1}$

ball bar #3

Super Invar, nominal length 800 mm center-to-center (Serial-# UHP-SI-NIST-01) , thermal expansion coefficient $\alpha = 1.14 \times 10^{-6} \text{ K}^{-1}$

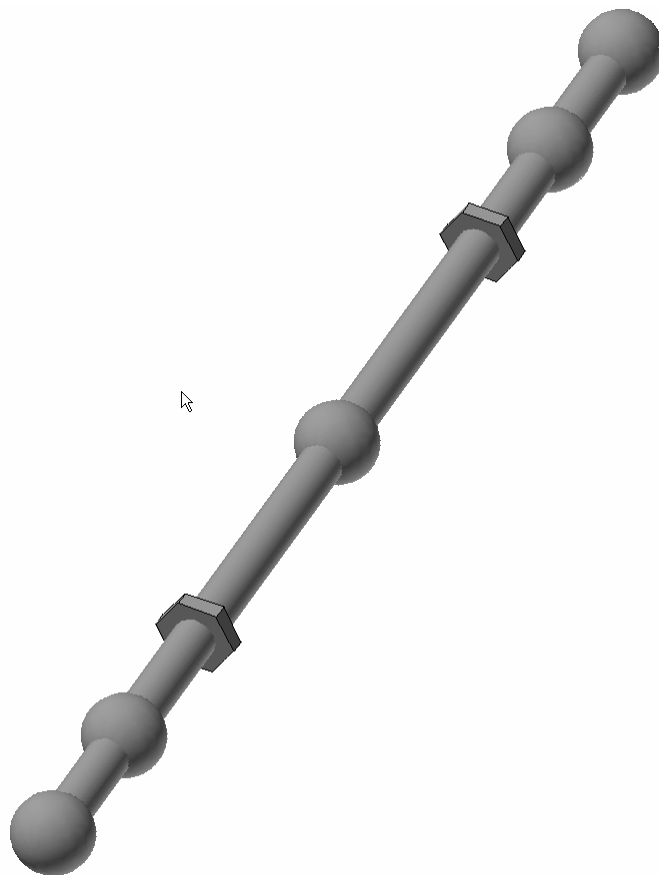

Fig. 1 : Design of the ball bars

3.2 Step Gauge

A KOBA step gauge was donated by PTB. It has a steel frame, ceramic gauges, and 1000 mm nominal length. The thermal expansion coefficient is $\alpha = 11.5 \times 10^{-6} \text{ K}^{-1}$. The step gauge was sent around inside the original wooden transport box.

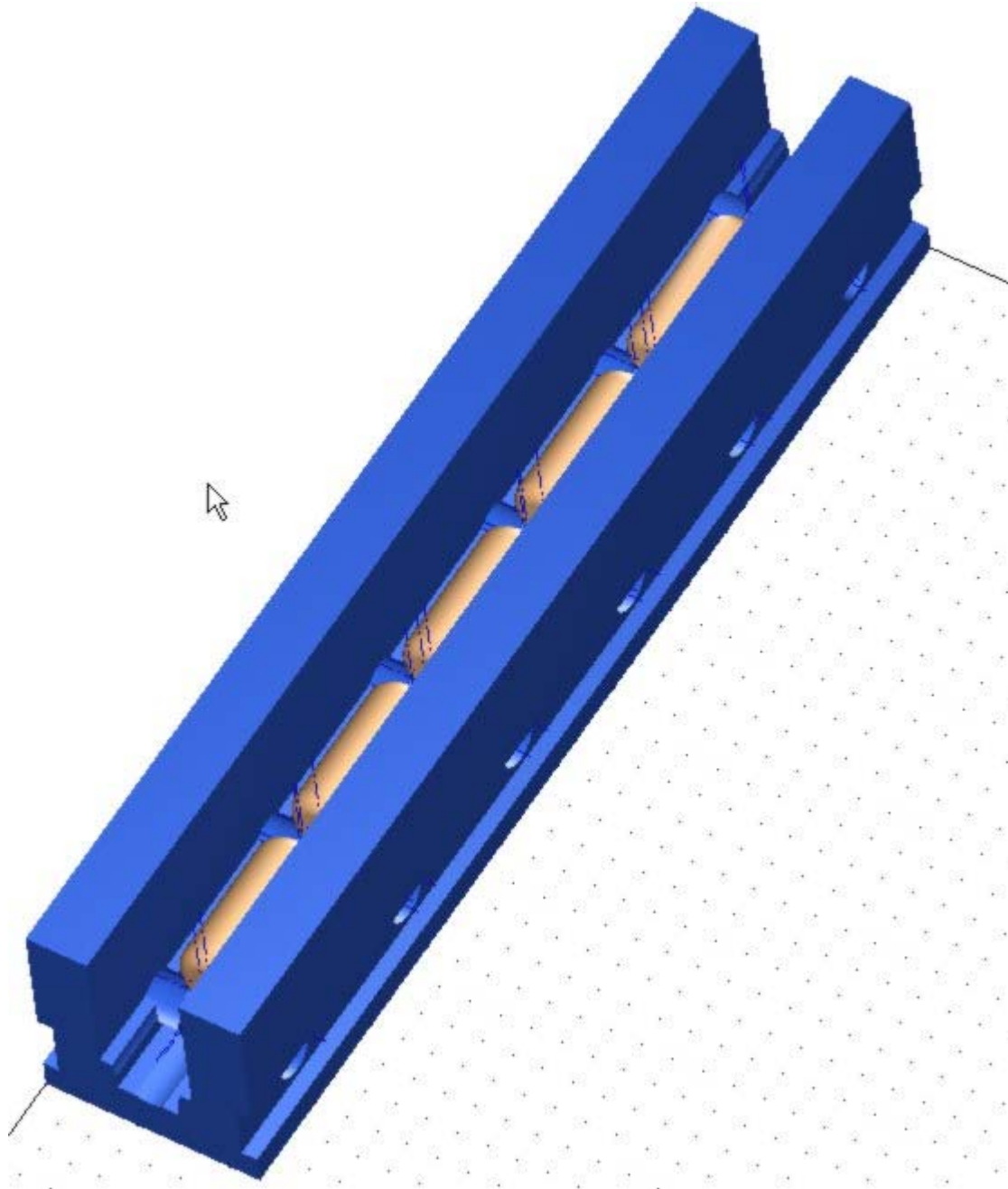

Fig. 2: Principal design of a KOBA step-gauge

3.3 Transport Damage

At arrival at NIST the wooden box containing the step-gauge was seriously damaged. One of the clamps for locking the box was torn off. Fortunately re-calibration results did not show any damage or change to the step-gauge. NIST had repaired the box.



Fig. 3 Damage to shipping box of step gauge

4 Measurement instructions and reporting of the results

4.1 Traceability

Length measurements should be independently traceable to the latest realisation of the metre as set out in the current "Mise en Pratique". This means that if for example the step gauge would have been measured by a CMM, that the traceability chain should not rely on another step-gauge or ball-bar, but for example on a calibration by interferometric means.

Temperature measurements should be made using the International Temperature Scale of 1990 (ITS-90).

4.2 Measurands

The measurand of the ball bars was the distance of the sphere centres of the balls attached to either end of the bar.

The measurand of the step gauge was the distances of the centres of the front and back faces of the individual gauges of the step-gauge with respect to the centre of the front face of the first gauge. The measurements should be carried out as much as possible near the centres of the front faces of the gauges or along an axis which passes through the centre of the measuring face No. 0 and is parallel to both the bottom face and the side alignment face.

The thermal expansion coefficient of the artefacts was determined before the start of the comparison. Laboratories had to use these measured expansion coefficients when measuring the artefacts. Laboratories should report the temperatures at which the length measurements were made. Laboratories should only measure the artefacts at a temperature close to 20°C.

4.3 Inspection of the artefacts

Before calibration, the artefacts had to be inspected for damage to the measurement surfaces and side faces. Any scratches, rusty spots or other damages had to be documented.

4.4 Alignment

The alignment of the step gauge was performed by using the bottom face of the groove where the gauges are fixed and the side-walls. In case a different alignment procedure was preferred by the laboratory or needed because of equipment constraints documentation was requested. The step-gauge should be supported at the Bessel points.

Included with the ball bars was a stand for mounting the bars in a horizontal position. The use of this stand was intended to minimize apparent length measurement errors due to mounting problems. The stand consists of two similar bases, one for each end of the ball bar. One mount has three small hemispheres, and the other has two semi-cylinders, together they form a kinematic mounting system. Each kinematic component includes a small magnet which provides a force (in addition to gravity) to firmly hold the ball bar in place under significant CMM probing forces. In order for the mount to function properly it is important that the kinematic components be clean and free from debris. Alcohol could be used to clean the components.

The large stainless steel disc of each base was designed for secure mounting on any CMM or other machine table. There were powerful magnets in the bottom of each base which provide sufficient force which allowed mounting to any steel or iron surface. Alternatively, external clamps (as used for mounting parts) could be applied to the base. Since there was an annular ring around the bottom of the base, it was desirable to place the clamp tip well inside the outer perimeter of the base

The bases should be separated by the distance between the mounting balls on the ball bar (the two balls which are closest together), which is 700 mm on the long bars and 300 mm on the short bar. The base with the two semi-cylinders should be aligned so that the cylinder axes were approximately parallel to the ball bar axis. The mounting balls of the ball bar should form a clean metal-to-metal contact with the kinematic components. The gauging balls will extend 50 mm beyond the mounting base.

Each ball bar had a small flat disk mounted on the side of the bar near the middle. This is intended to make temperature sensor mounting more convenient, especially for magnetically held sensors.

4.5 Expansion Correction

The measurement results had to be appropriately corrected to the reference temperature of 20 °C using the values of the thermal expansion coefficient provided by the pilot laboratory.

4.6 Reporting of incomplete data

If for any reason a laboratory was not able to measure one group of the standards (ball bars or step gauge) or the length, it was encouraged to report the incomplete results.

4.7 Measurement Uncertainty

The uncertainty of measurement should be estimated according to the *ISO Guide to the Expression of Uncertainty in Measurement*. Because for this key comparison the measurement equipment and procedure was not fixed it was not possible to develop a full mathematical model for the measurement uncertainty for all participants.

5 Stability and condition of the Artefacts

5.1 Step Gauge Stability

Two calibrations of the step gauge were performed by PTB, one in 1999, and one in 2000. No significant change was observed. Fig. 4 shows the resulting data and its corresponding uncertainties. It was decided to use only the data of 2000 for further analysis.

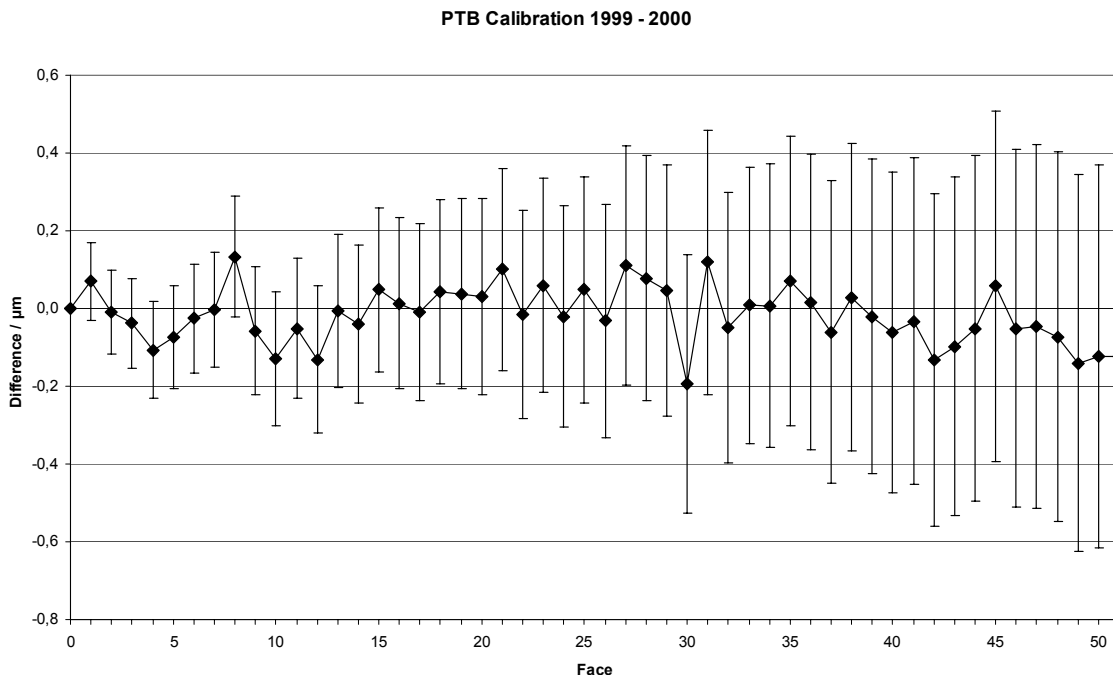

Fig. 4: Difference between PTB calibration of step gauge in 1999 and 2000

5.1 Ball Bar Stability

Three calibrations of the ball bars were performed by PTB, in 1998, 1999, and 2000. The steel bars remained unchanged within uncertainty. The INVAR bar calibration differed significantly between 1998 and 1999. The deviation between 1999 and 2000 was much smaller but still significant. Therefore it seems that the INVAR material was not in a final state and changed the dimensions of the ball while relaxing. Fig. 5 shows the change of the length values over time. The reference as defined in chapter 8.7 was applied.

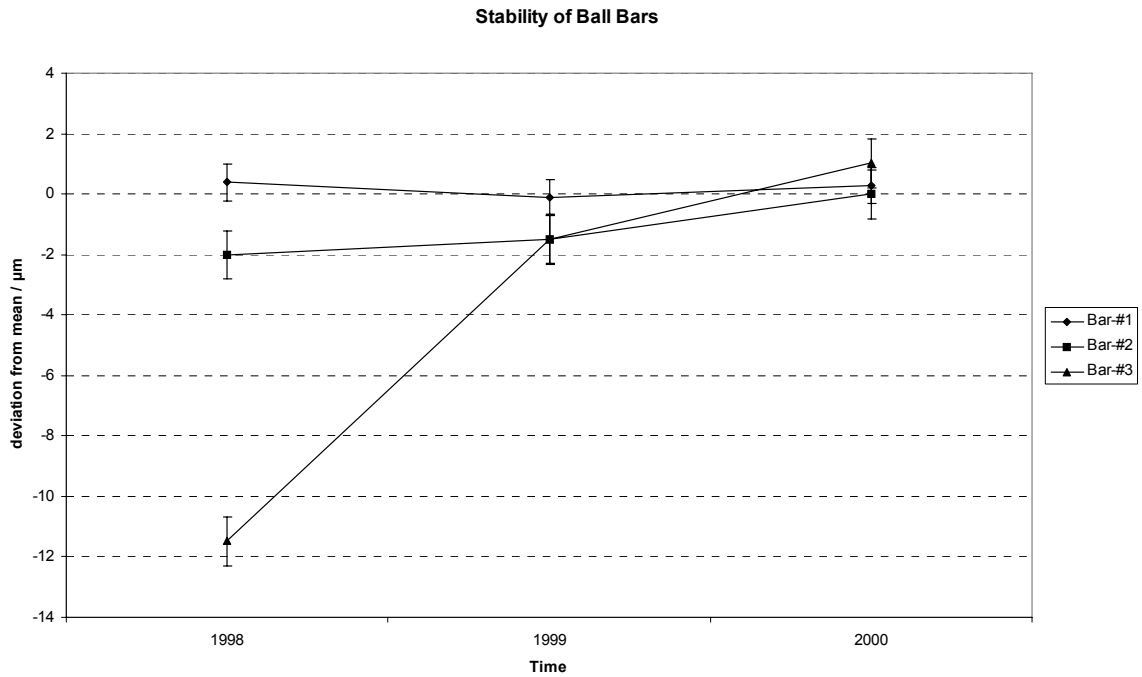

Fig. 5 : Stability of Ball Bars

6 Measurement results, as reported by participants

6.1 Step gauge data

Not all participants reported step gauge data. Some data sets do not cover the full length of the step gauge, because the corresponding participant was limited by their measurement range. METAS reported data for two directions of measurement. These data differ only slightly within the uncertainty. Only one direction was selected for further comparison.

Face	PTB_99	PTB_00	CEM	CENAM	KRISS	METAS	NIM	NMIJ	NIST	CSIRO
0	0.00000	0.00000	0.00000	0.00000	0.00000	0.00000	0.00000	0.00000	0.00000	0.00000
1	20.00130	20.00123	20.00122	20.00110	20.00025	20.00120	20.00170	20.00144	20.00136	20.00159
2	40.00990	40.00991	40.00997	40.01010	40.00996	40.00994	40.01000	40.01001	40.01001	40.00977
3	60.01070	60.01074	60.01065	60.01060	60.00965	60.01058	60.01120	60.01090	60.01083	60.01078
4	80.01190	80.01201	80.01210	80.01200	80.01185	80.01190	80.01190	80.01194	80.01227	80.01156
5	100.01290	100.01297	100.01306	100.01280	100.01185	100.01287	100.01340	100.01313	100.01303	100.01284
6	120.01490	120.01493	120.01499	120.01510	120.01483	120.01496	120.01490	120.01497	120.01499	120.01440
7	140.01600	140.01600	140.01603	140.01600	140.01488	140.01596	140.01650	140.01621	140.01616	140.01575
8	160.04800	160.04787	160.04795	160.04780	160.04762	160.04788	160.04780	160.04778	160.04781	160.04714
9	180.04870	180.04876	180.04882	180.04860	180.04747	180.04870	180.04900	180.04883	180.04880	180.04826
10	200.04340	200.04353	200.04349	200.04380	200.04341	200.04341	200.04340	200.04363	200.04360	200.04263
11	220.04470	220.04475	220.04476	220.04480	220.04363	220.04457	220.04510	220.04503	220.04501	220.04413
12	240.05120	240.05133	240.05134	240.05160	240.05114	240.05124	240.05120	240.05138	240.05148	240.05026
13	260.05200	260.05201	260.05216	260.05220	260.05095	260.05197	260.05250	260.05234	260.05233	260.05129
14	280.06220	280.06224	280.06229	280.06230	280.06195	280.06239	280.06210	280.06221	280.06227	280.06107
15	300.06380	300.06375	300.06376	300.06350	300.06238	300.06378	300.06410	300.06378	300.06379	300.06275
16	320.04660	320.04659	320.04659	320.04670	320.04642	320.04656	320.04650	320.04666	320.04678	320.04529
17	340.04730	340.04731	340.04726	340.04730	340.04609	340.04716	340.04770	340.04748	340.04753	340.04616
18	360.04920	360.04916	360.04926	360.04920	360.04896	360.04929	360.04920	360.04917	360.04929	360.04774
19	380.05040	380.05036	380.05037	380.05010	380.04907	380.05031	380.05070	380.05045	380.05048	380.04913
20	400.05640	400.05637	400.05631	400.05640	400.05610	400.05640	400.05620	400.05630	400.05643	400.05471
21	420.05720	420.05710	420.05715	420.05690	420.05590	420.05713	420.05740	420.05726	420.05729	420.05575
22	440.06310	440.06312	440.06311	440.06310	440.06284	440.06316	440.06290	440.06306	440.06323	440.06136
23	460.06420	460.06414	460.06415	460.06390	460.06274	460.06406	460.06430	460.06416	460.06426	460.06255
24	480.06300	480.06302	480.06296	480.06300	480.06265	480.06302	480.06280	480.06298	480.06315	480.06107
25	500.06390	500.06385	500.06384	500.06370	500.06246	500.06376	500.06400	500.06395	500.06404	500.06218
26	520.06260	520.06263	520.06244	520.06280	520.06228	520.06264	520.06240	520.06263	520.06278	520.06061
27	540.06360	540.06349	540.06340	540.06340	540.06215	540.06338	540.06360	540.06367	540.06373	540.06155
28	560.07030	560.07022	560.07003	560.07010	560.06969	560.07030	560.06980	560.07001	560.07016	560.06790
29	580.07140	580.07135	580.07121	580.07100	580.06976	580.07137	580.07140	580.07128	580.07138	580.06920
30	600.07570	600.07589	600.07580	600.07590	600.07520	600.07599	600.07560	600.07559	600.07566	600.07332
31	620.07690	620.07678	620.07669	620.07660	620.07531	620.07677	620.07690	620.07681	620.07689	620.07462
32	640.10790	640.10795	640.10768	640.10800	640.10749	640.10786	640.10750	640.10784	640.10796	640.10530
33	660.10850	660.10849	660.10833	660.10850	660.10714	660.10839	660.10850	660.10863	660.10873	660.10618
34	680.12800	680.12799	680.12775	680.12800	680.12753	680.12790	680.12740	680.12783	680.12800	680.12523
35	700.12940	700.12933	700.12920	700.12920	700.12793	700.12926	700.12920	700.12940	700.12954	700.12714
36	720.13010	720.13008	720.12987	720.13000	720.12955	720.13011	720.12950	720.12988	720.13002	
37	740.13090	740.13096	740.13076	740.13070	740.12946	740.13090	740.13080		740.13102	
38	760.13010	760.13007	760.12984	760.13000	760.12960	760.13012	760.12950		760.13004	
39	780.13100	780.13102	780.13074	780.13070	780.12944	780.13098	780.13080		780.13097	
40	800.12960	800.12966	800.12939	800.12940	800.12888	800.12976	800.12910		800.12959	
41	820.13110	820.13113	820.13081	820.13060	820.12951	820.13111	820.13090		820.13104	
42	840.13160	840.13173	840.13145	840.13150	840.13128	840.13168	840.13110		840.13174	
43	860.13240	860.13250	860.13221	860.13210	860.13106	860.13238	860.13240		860.13256	
44	880.13770	880.13775	880.13737	880.13740	880.13724	880.13780	880.13710		880.13768	
45	900.13910	900.13904	900.13863	900.13840	900.13761	900.13897	900.13880		900.13897	
46	920.14870	920.14875	920.14837	920.14830	920.14837	920.14872	920.14800		920.14863	
47	940.15010	940.15015	940.14974	940.14950	940.14891	940.15003	940.14990		940.15016	
48	960.18940	960.18947	960.18901	960.18890	960.18906	960.18947	960.18860		960.18928	
49	980.19020	980.19034	980.18978	980.18950	980.18885	980.19019	980.18990		980.19015	
50	1000.21020	1000.21032	1000.20983	1000.20980	1000.20994	1000.21022	1000.20940		1000.21016	
51	1020.21110	1020.21122	1020.21076	1020.21050	1020.20994	1020.21106	1020.21090		1020.21128	

Table 2: Step gauge data as reported by the participants. All values are given in mm.

6.2 Ball bar data

Not all participants reported (all) ball bar data. Table 3 lists the ball bar data as reported by the participants. The data is given as deviation from the nominal length of the ball bar. Participants NMIJ and CSIRO report only a value for Bar-#1.

Artefact	PTB	KRISS	NMIJ	NIM	NIST	CSIRO
Bar-#1	5,1	4,71	5	5,22	4,99	3,87
Bar-#2	-10,3	-9,83		-10,32	-10,69	
Bar-#3	-2105,7	-2107,08		-2105,99	-2108,1	

Table 3 : Ball bar data (Deviation from nominal) as reported by the participants.

All values are given in μm .

7 Measurement uncertainties

The technical protocol specified that the uncertainty of measurement should be estimated according to the *ISO Guide to the Expression of Uncertainty in Measurement*. Full mathematical models were not developed in the protocol because the participants used a range of different techniques. As a result it has not been possible to compare uncertainty budgets.

7.1 Step gauge data uncertainty

Table 4 lists the reported standard measurement uncertainty for the step gauge data of Table 2.

Face	PTB	CEM	CENAM	KRISS	METAS	NIM	NMIJ	NIST	CSIRO
0	0.10	0.05	0.63	0.00	0.07	0.20	0.18	0.11	0.11
1	0.11	0.05	0.66	0.23	0.07	0.20	0.19	0.11	0.11
2	0.12	0.05	0.70	0.11	0.07	0.20	0.20	0.11	0.11
3	0.12	0.05	0.74	0.23	0.07	0.20	0.21	0.11	0.12
4	0.13	0.05	0.77	0.12	0.07	0.20	0.22	0.11	0.12
5	0.14	0.05	0.81	0.24	0.07	0.20	0.23	0.12	0.13
6	0.15	0.05	0.84	0.13	0.07	0.20	0.24	0.12	0.13
7	0.16	0.06	0.88	0.25	0.07	0.20	0.25	0.12	0.14
8	0.16	0.06	0.92	0.15	0.08	0.20	0.26	0.12	0.15
9	0.17	0.06	0.95	0.26	0.08	0.20	0.27	0.12	0.16
10	0.18	0.07	0.99	0.17	0.08	0.20	0.28	0.13	0.17
11	0.19	0.07	1.02	0.27	0.09	0.20	0.29	0.13	0.18
12	0.20	0.08	1.06	0.19	0.09	0.20	0.30	0.13	0.19
13	0.20	0.08	1.10	0.29	0.09	0.20	0.30	0.13	0.20
14	0.21	0.08	1.13	0.22	0.10	0.20	0.31	0.13	0.21
15	0.22	0.09	1.17	0.31	0.10	0.20	0.32	0.14	0.22
16	0.23	0.09	1.21	0.25	0.10	0.20	0.33	0.14	0.23
17	0.24	0.10	1.24	0.33	0.11	0.20	0.34	0.14	0.24
18	0.24	0.10	1.28	0.27	0.11	0.20	0.35	0.14	0.25
19	0.25	0.11	1.31	0.35	0.12	0.20	0.36	0.14	0.26
20	0.26	0.11	1.35	0.30	0.12	0.20	0.37	0.15	0.27
21	0.27	0.11	1.39	0.37	0.12	0.20	0.38	0.15	0.28
22	0.28	0.12	1.42	0.33	0.13	0.20	0.39	0.15	0.30
23	0.28	0.12	1.46	0.38	0.13	0.30	0.40	0.15	0.31
24	0.29	0.13	1.49	0.35	0.14	0.30	0.41	0.15	0.32
25	0.30	0.13	1.53	0.41	0.14	0.30	0.42	0.16	0.33
26	0.31	0.14	1.57	0.37	0.15	0.30	0.43	0.16	0.34
27	0.32	0.14	1.60	0.43	0.15	0.30	0.44	0.16	0.35
28	0.32	0.15	1.64	0.40	0.16	0.30	0.45	0.16	0.37
29	0.33	0.15	1.68	0.45	0.16	0.30	0.46	0.17	0.38
30	0.34	0.16	1.71	0.42	0.16	0.30	0.47	0.17	0.39
31	0.35	0.16	1.75	0.47	0.17	0.30	0.48	0.17	0.40
32	0.36	0.17	1.78	0.44	0.17	0.30	0.49	0.17	0.41
33	0.36	0.17	1.82	0.50	0.18	0.30	0.50	0.17	0.43
34	0.37	0.18	1.86	0.46	0.18	0.30	0.51	0.18	0.44
35	0.38	0.18	1.89	0.51	0.19	0.30	0.52	0.18	0.45
36	0.39	0.19	1.93	0.49	0.19	0.30	0.53	0.18	
37	0.40	0.19	1.96	0.53	0.20	0.30		0.18	
38	0.40	0.20	2.00	0.50	0.20	0.30		0.18	
39	0.41	0.20	2.04	0.56	0.21	0.30		0.19	
40	0.42	0.21	2.07	0.53	0.21	0.30		0.19	
41	0.43	0.21	2.11	0.58	0.22	0.30		0.19	
42	0.44	0.22	2.15	0.55	0.22	0.30		0.19	
43	0.44	0.22	2.18	0.61	0.23	0.30		0.19	
44	0.45	0.23	2.22	0.59	0.23	0.30		0.20	
45	0.46	0.23	2.25	0.64	0.24	0.30		0.20	
46	0.47	0.23	2.29	0.61	0.24	0.30		0.20	
47	0.48	0.24	2.33	0.65	0.24	0.30		0.20	
48	0.48	0.24	2.36	0.65	0.25	0.30		0.20	
49	0.49	0.25	2.40	0.68	0.25	0.30		0.20	
50	0.50	0.25	2.44	0.68	0.26	0.30		0.21	
51	0.51	0.26	2.47	0.71	0.26	0.30		0.21	

Table 4 : Step gauge data standard uncertainties as reported by the participants in μm .

7.2 Ball bar data uncertainty

Table 5 lists the reported standard measurement for the ball bar data in Table 3.

Artefact	PTB	KRISS	NMIJ	NIM	NIST	CSIRO
Bar-#1	0,600	0,606	0,538	0,200	0,160	0,500
Bar-#2	0,800	0,774		0,300	0,200	
Bar-#3	0,800	0,721		0,190	0,200	

Table 5 : Ball bar data standard uncertainties as reported by the participants.

All values are given in μm .

8 Analysis of the reported results

8.1 Reference values for Step Gauge: NMIJ-METAS-NIST-PTB Mean Reference

In the analysis of earlier step-gauge comparisons (EUROMET -#372) the data sets were shifted by their mean offset to overcome the strong dependence on the reference zero point. In this comparison several labs appear to have a strong modulation due to a bi-directional probing error and this further complicated the picture when considering such an approach. Four laboratories, NMIJ, METAS, NIST and PTB reported values with close agreement, forming the largest consistent subset of the participants. A simple mean was therefore calculated, based on the measurements of METAS, NMIJ, NIST, and PTB

$$x_{ref} = \frac{1}{n} \sum_{j=1}^n x_j, \quad (1)$$

where $n = 4$ and $j = \text{NMIJ, METAS, NIST, PTB}$. The uncertainty is,

$$u(x_{ref}) = \frac{1}{n} \sqrt{\sum_{i=1}^n u^2(x_i)} \quad (2)$$

8.2 Step gauge deviations from reference value and uncertainty of deviations

The deviation of each laboratory's result from the reference is determined simply as $x_i - x_{ref}$. The uncertainty of this deviation is calculated as a combination of the uncertainties of the result, $u(x_i)$, and the uncertainty of the mean $u(x_{ref})$. For those laboratories whose measurements are not used to calculate the reference the uncertainty is uncorrelated and given by

$$u(x_i - x_{ref}) = \sqrt{u^2(x_i) + u^2(x_{ref})} \quad (3)$$

The four laboratories that define the mean have measurement values that are correlated with the reference and the uncertainty is given by

$$u(x_i - x_{ref}) = \sqrt{\left(1 - \frac{2}{n}\right) u^2(x_i) + \frac{1}{n^2} \sum_{j=1}^n u^2(x_j)} \quad (4)$$

for $n = 4$ and $j = \text{NMIJ, METAS, NIST \& PTB}$.

Reference values and their uncertainties are shown in Table 6. Figure 6 shows all the results minus this reference value for all labs. Figures 7 – 15 show individual results in more detail. Table 7 gives the numerical values of the Degrees of Equivalence.

Face	PTB	METAS	NMIJ	NIST	MEAN	Uncert
0	0.00000	0.00000	0.00000	0.00000	0.00000	0.06
1	20.00123	20.00120	20.00144	20.00136	20.00131	0.06
2	40.00991	40.00994	40.01001	40.01001	40.00997	0.07
3	60.01074	60.01058	60.01090	60.01083	60.01076	0.07
4	80.01201	80.01190	80.01194	80.01227	80.01203	0.07
5	100.01297	100.01287	100.01313	100.01303	100.01300	0.08
6	120.01493	120.01496	120.01497	120.01499	120.01496	0.08
7	140.01600	140.01596	140.01621	140.01616	140.01608	0.08
8	160.04787	160.04788	160.04778	160.04781	160.04783	0.08
9	180.04876	180.04870	180.04883	180.04880	180.04877	0.09
10	200.04353	200.04341	200.04363	200.04360	200.04354	0.09
11	220.04475	220.04457	220.04503	220.04501	220.04484	0.09
12	240.05133	240.05124	240.05138	240.05148	240.05136	0.10
13	260.05201	260.05197	260.05234	260.05233	260.05216	0.10
14	280.06224	280.06239	280.06221	280.06227	280.06228	0.10
15	300.06375	300.06378	300.06378	300.06379	300.06378	0.11
16	320.04659	320.04656	320.04666	320.04678	320.04665	0.11
17	340.04731	340.04716	340.04748	340.04753	340.04737	0.11
18	360.04916	360.04929	360.04917	360.04929	360.04923	0.12
19	380.05036	380.05031	380.05045	380.05048	380.05040	0.12
20	400.05637	400.05640	400.05630	400.05643	400.05638	0.12
21	420.05710	420.05713	420.05726	420.05729	420.05719	0.13
22	440.06312	440.06316	440.06306	440.06323	440.06314	0.13
23	460.06414	460.06406	460.06416	460.06426	460.06416	0.13
24	480.06302	480.06302	480.06298	480.06315	480.06304	0.14
25	500.06385	500.06376	500.06395	500.06404	500.06390	0.14
26	520.06263	520.06264	520.06263	520.06278	520.06267	0.14
27	540.06349	540.06338	540.06367	540.06373	540.06357	0.15
28	560.07022	560.07030	560.07001	560.07016	560.07017	0.15
29	580.07135	580.07137	580.07128	580.07138	580.07135	0.15
30	600.07589	600.07599	600.07559	600.07566	600.07578	0.16
31	620.07678	620.07677	620.07681	620.07689	620.07681	0.16
32	640.10795	640.10786	640.10784	640.10796	640.10790	0.16
33	660.10849	660.10839	660.10863	660.10873	660.10856	0.17
34	680.12799	680.12790	680.12783	680.12800	680.12793	0.17
35	700.12933	700.12926	700.12940	700.12954	700.12938	0.17
36	720.13008	720.13011	720.12988	720.13002	720.13002	0.18
37	740.13096	740.13090		740.13102	740.13096	0.16
38	760.13007	760.13012		760.13004	760.13008	0.16
39	780.13102	780.13098		780.13097	780.13099	0.17
40	800.12966	800.12976		800.12959	800.12967	0.17
41	820.13113	820.13111		820.13104	820.13109	0.17
42	840.13173	840.13168		840.13174	840.13172	0.17
43	860.13250	860.13238		860.13256	860.13248	0.18
44	880.13775	880.13780		880.13768	880.13774	0.18
45	900.13904	900.13897		900.13897	900.13899	0.19
46	920.14875	920.14872		920.14863	920.14870	0.19
47	940.15015	940.15003		940.15016	940.15011	0.19
48	960.18947	960.18947		960.18928	960.18941	0.19
49	980.19034	980.19019		980.19015	980.19023	0.20
50	1000.21032	1000.21022		1000.21016	1000.21023	0.20
51	1020.21122	1020.21106		1020.21128	1020.21119	0.20

Table 6: Reference values (mean in mm) and their corresponding uncertainties (μm)

Face	PTB	CEM	CENAM	KRISS	METAS	NIM	NMIJ	NIST	CSIRO
0	0.00	0.00	0.00	0.00	0.00	0.00	0.00	0.00	0.00
1	-0.08	-0.09	-0.21	-1.06	-0.11	0.39	0.14	0.05	0.29
2	-0.06	0.00	0.13	-0.01	-0.03	0.03	0.04	0.04	-0.17
3	-0.02	-0.11	-0.16	-1.11	-0.18	0.44	0.14	0.07	0.04
4	-0.02	0.07	-0.03	-0.18	-0.13	-0.13	-0.09	0.24	-0.43
5	-0.03	0.06	-0.20	-1.15	-0.13	0.40	0.13	0.03	-0.20
6	-0.04	0.03	0.14	-0.13	0.00	-0.06	0.01	0.03	-0.56
7	-0.08	-0.05	-0.08	-1.20	-0.12	0.42	0.13	0.08	-0.28
8	0.03	0.12	-0.03	-0.22	0.05	-0.03	-0.06	-0.02	-0.73
9	-0.01	0.05	-0.17	-1.30	-0.07	0.23	0.06	0.03	-0.47
10	-0.01	-0.05	0.26	-0.14	-0.13	-0.14	0.08	0.06	-0.94
11	-0.09	-0.08	-0.04	-1.21	-0.27	0.26	0.19	0.17	-0.74
12	-0.03	-0.02	0.24	-0.22	-0.12	-0.16	0.02	0.12	-1.06
13	-0.15	0.00	0.04	-1.22	-0.19	0.34	0.18	0.17	-0.86
14	-0.04	0.01	0.02	-0.33	0.11	-0.18	-0.07	-0.01	-1.18
15	-0.02	-0.02	-0.28	-1.40	0.00	0.32	0.01	0.01	-0.98
16	-0.06	-0.06	0.05	-0.23	-0.09	-0.15	0.01	0.13	-1.35
17	-0.06	-0.11	-0.07	-1.28	-0.21	0.33	0.11	0.16	-1.17
18	-0.07	0.03	-0.03	-0.27	0.06	-0.03	-0.06	0.06	-1.53
19	-0.04	-0.03	-0.30	-1.33	-0.09	0.30	0.05	0.08	-1.30
20	-0.01	-0.07	0.02	-0.27	0.02	-0.18	-0.07	0.05	-1.68
21	-0.10	-0.04	-0.29	-1.30	-0.06	0.21	0.06	0.10	-1.39
22	-0.03	-0.03	-0.04	-0.30	0.02	-0.24	-0.08	0.09	-1.74
23	-0.02	-0.01	-0.26	-1.41	-0.10	0.14	0.01	0.10	-1.66
24	-0.02	-0.08	-0.04	-0.39	-0.02	-0.24	-0.06	0.11	-1.94
25	-0.05	-0.06	-0.20	-1.44	-0.14	0.10	0.05	0.14	-1.70
26	-0.04	-0.23	0.13	-0.39	-0.03	-0.27	-0.04	0.11	-2.07
27	-0.08	-0.17	-0.17	-1.42	-0.19	0.03	0.10	0.16	-1.97
28	0.05	-0.14	-0.07	-0.48	0.13	-0.37	-0.16	-0.01	-2.27
29	0.01	-0.14	-0.35	-1.59	0.02	0.05	-0.07	0.03	-2.15
30	0.11	0.02	0.12	-0.58	0.21	-0.18	-0.20	-0.12	-2.48
31	-0.03	-0.12	-0.21	-1.50	-0.04	0.09	-0.01	0.08	-2.21
32	0.05	-0.22	0.10	-0.41	-0.04	-0.40	-0.07	0.06	-2.60
33	-0.07	-0.23	-0.06	-1.42	-0.17	-0.06	0.07	0.17	-2.36
34	0.06	-0.18	0.07	-0.40	-0.03	-0.53	-0.10	0.07	-2.73
35	-0.05	-0.18	-0.18	-1.46	-0.12	-0.18	0.02	0.16	-2.28
36	0.06	-0.15	-0.02	-0.48	0.09	-0.52	-0.14	0.00	
37	0.00	-0.20	-0.26	-1.50	-0.06	-0.16		0.06	
38	-0.01	-0.24	-0.08	-0.48	0.04	-0.58		-0.04	
39	0.03	-0.25	-0.29	-1.56	-0.01	-0.19		-0.02	
40	-0.01	-0.28	-0.27	-0.79	0.09	-0.57		-0.08	
41	0.04	-0.28	-0.49	-1.59	0.02	-0.19		-0.05	
42	0.02	-0.27	-0.22	-0.44	-0.04	-0.62		0.02	
43	0.02	-0.27	-0.38	-1.42	-0.10	-0.08		0.08	
44	0.01	-0.37	-0.34	-0.51	0.06	-0.64		-0.06	
45	0.05	-0.36	-0.59	-1.39	-0.02	-0.19		-0.02	
46	0.05	-0.33	-0.40	-0.33	0.02	-0.70		-0.07	
47	0.03	-0.37	-0.61	-1.21	-0.08	-0.21		0.05	
48	0.07	-0.40	-0.51	-0.35	0.06	-0.81		-0.13	
49	0.11	-0.45	-0.73	-1.38	-0.04	-0.33		-0.08	
50	0.09	-0.40	-0.43	-0.30	-0.01	-0.83		-0.07	
51	0.035	-0.43	-0.69	-1.25	-0.13	-0.29		0.09	

Table 7: Reported step gauge data – Reference (μm)

FACE	PTB	CEM	CENAM	KRISS	METAS	NIM	NMIJ	NIST	CSIRO
0	0.19	0.15	1.26	0.12	0.16	0.42	0.28	0.20	0.26
1	0.20	0.16	1.33	0.47	0.16	0.42	0.30	0.20	0.26
2	0.21	0.16	1.40	0.25	0.17	0.42	0.31	0.20	0.26
3	0.22	0.17	1.48	0.48	0.17	0.42	0.33	0.21	0.27
4	0.24	0.17	1.55	0.28	0.17	0.42	0.34	0.21	0.28
5	0.25	0.18	1.62	0.50	0.18	0.43	0.36	0.23	0.30
6	0.26	0.19	1.70	0.31	0.18	0.43	0.37	0.23	0.31
7	0.27	0.20	1.77	0.52	0.19	0.43	0.39	0.23	0.33
8	0.29	0.21	1.84	0.34	0.20	0.43	0.40	0.24	0.34
9	0.30	0.22	1.91	0.54	0.21	0.44	0.42	0.24	0.36
10	0.31	0.23	1.99	0.39	0.21	0.44	0.43	0.26	0.38
11	0.33	0.24	2.06	0.57	0.23	0.44	0.45	0.26	0.40
12	0.34	0.25	2.13	0.43	0.23	0.44	0.46	0.27	0.42
13	0.35	0.25	2.20	0.61	0.24	0.45	0.48	0.27	0.44
14	0.36	0.27	2.28	0.48	0.25	0.45	0.49	0.28	0.46
15	0.38	0.28	2.35	0.66	0.26	0.45	0.51	0.29	0.49
16	0.39	0.29	2.42	0.54	0.26	0.46	0.52	0.30	0.51
17	0.40	0.30	2.49	0.70	0.27	0.46	0.54	0.30	0.53
18	0.42	0.31	2.57	0.59	0.28	0.46	0.55	0.31	0.55
19	0.43	0.32	2.64	0.74	0.29	0.47	0.57	0.31	0.58
20	0.44	0.33	2.71	0.65	0.30	0.47	0.58	0.33	0.60
21	0.46	0.34	2.78	0.79	0.30	0.47	0.60	0.33	0.62
22	0.47	0.35	2.86	0.70	0.32	0.48	0.61	0.33	0.65
23	0.48	0.36	2.93	0.81	0.32	0.66	0.63	0.34	0.67
24	0.49	0.37	3.00	0.75	0.34	0.66	0.64	0.34	0.69
25	0.51	0.39	3.07	0.87	0.34	0.66	0.66	0.36	0.72
26	0.52	0.40	3.15	0.80	0.36	0.66	0.67	0.36	0.74
27	0.53	0.41	3.22	0.91	0.36	0.67	0.69	0.37	0.77
28	0.55	0.42	3.29	0.85	0.37	0.67	0.70	0.37	0.79
29	0.56	0.43	3.37	0.95	0.38	0.67	0.72	0.39	0.82
30	0.57	0.44	3.44	0.89	0.39	0.68	0.73	0.39	0.84
31	0.59	0.45	3.51	1.00	0.40	0.68	0.75	0.40	0.87
32	0.60	0.46	3.58	0.93	0.40	0.68	0.76	0.40	0.89
33	0.61	0.48	3.66	1.04	0.42	0.69	0.78	0.41	0.91
34	0.63	0.49	3.73	0.99	0.42	0.69	0.79	0.42	0.94
35	0.64	0.50	3.80	1.07	0.44	0.69	0.81	0.43	0.96
36	0.65	0.51	3.87	1.03	0.44	0.70	0.82	0.43	
37	0.61	0.50	3.94	1.10	0.37	0.68		0.35	
38	0.62	0.51	4.02	1.05	0.37	0.68		0.35	
39	0.63	0.52	4.09	1.16	0.39	0.69		0.37	
40	0.65	0.53	4.16	1.11	0.39	0.69		0.37	
41	0.66	0.54	4.23	1.21	0.40	0.69		0.37	
42	0.67	0.55	4.31	1.16	0.41	0.69		0.38	
43	0.68	0.57	4.38	1.26	0.42	0.70		0.38	
44	0.69	0.58	4.45	1.24	0.42	0.70		0.39	
45	0.71	0.59	4.52	1.32	0.44	0.71		0.40	
46	0.72	0.60	4.60	1.27	0.44	0.71		0.40	
47	0.73	0.61	4.67	1.34	0.44	0.71		0.40	
48	0.74	0.62	4.74	1.35	0.46	0.71		0.41	
49	0.76	0.63	4.81	1.41	0.46	0.72		0.41	
50	0.77	0.65	4.89	1.41	0.48	0.72		0.42	
51	0.78	0.66	4.96	1.47	0.48	0.72		0.43	

Table 8: Expanded uncertainty ($k=2$) for the values shown in
Table 7 (Step Gauge measurements – Reference) in μm

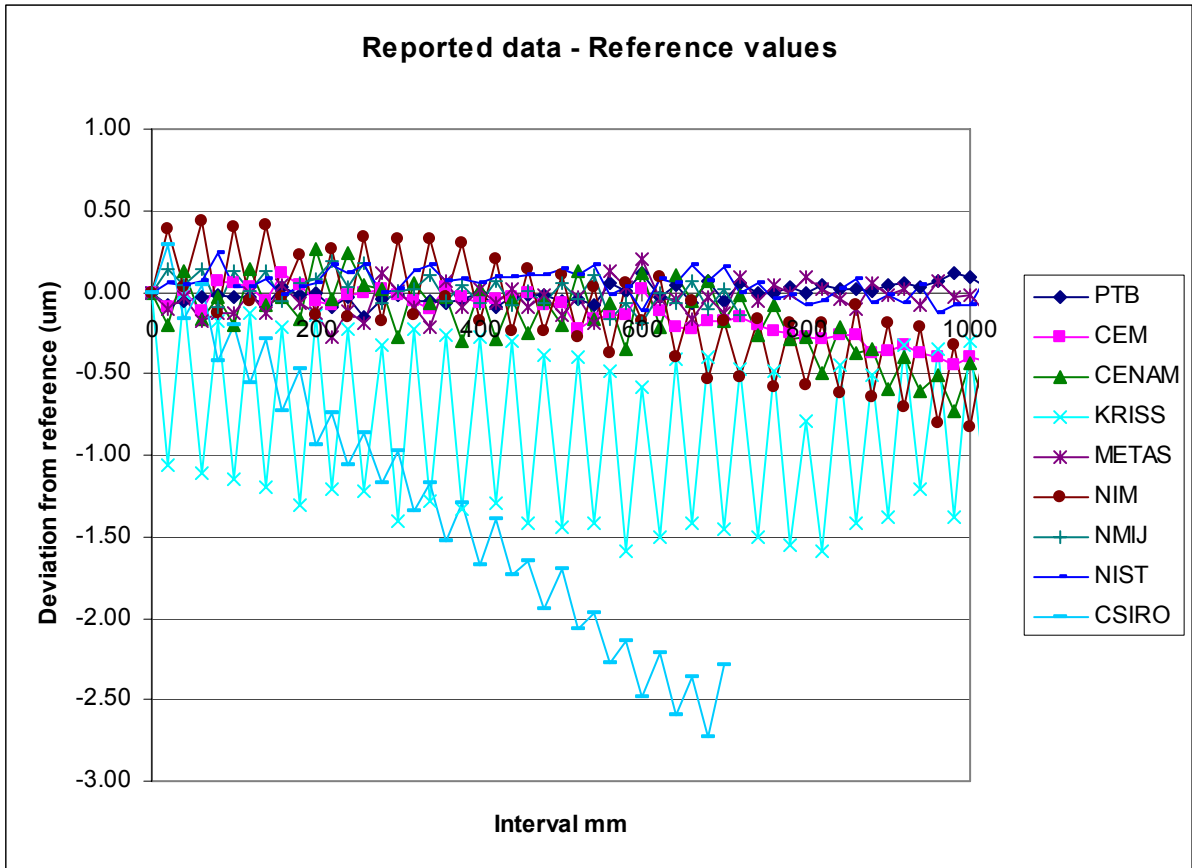

Fig. 6 : Reported Step gauge data - Reference

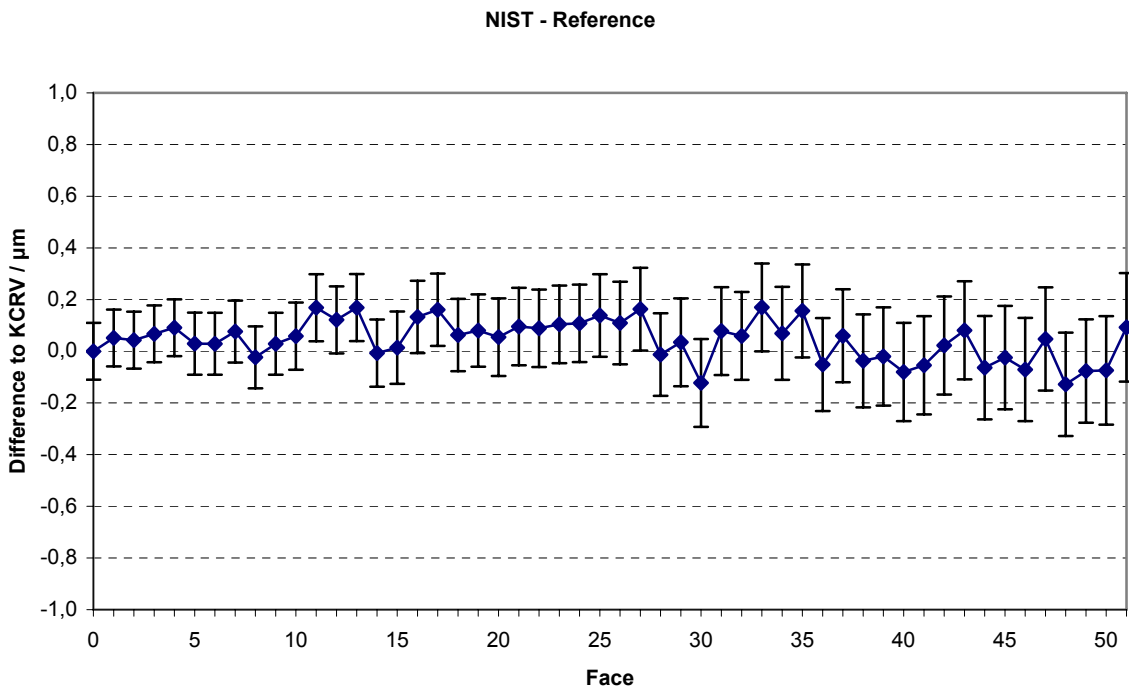

Fig. 7 : NIST step gauge data - Reference

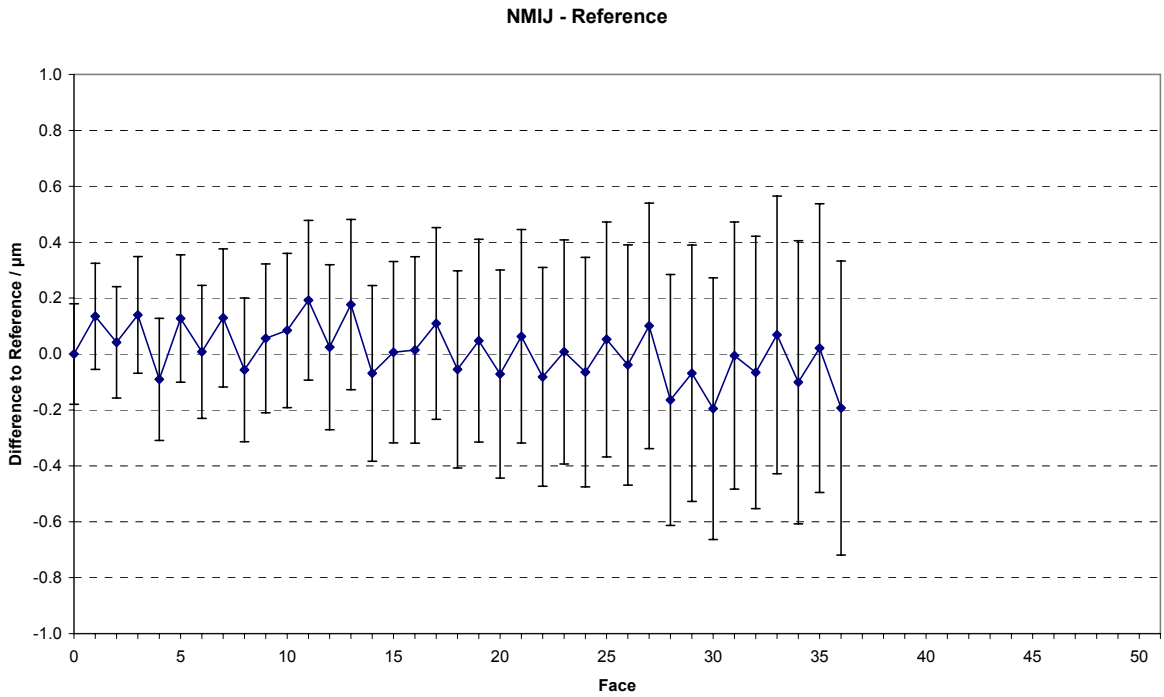

Fig. 8 : NMIJ step gauge data - Reference

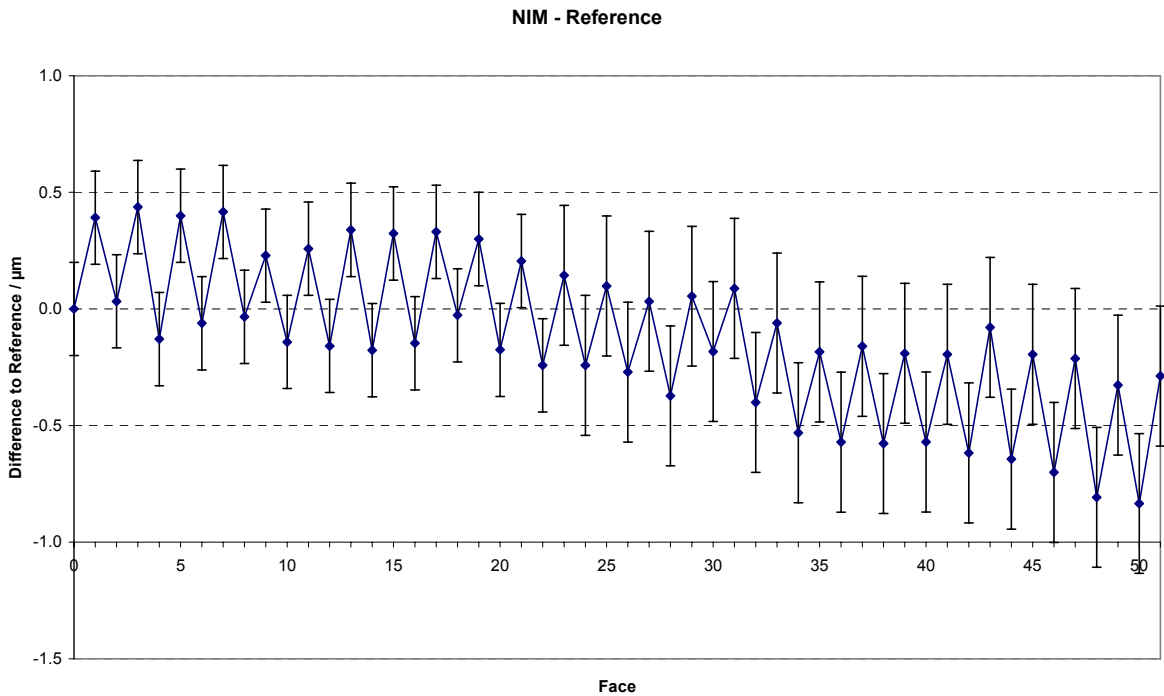

Fig. 9 : NIM step gauge data - Reference

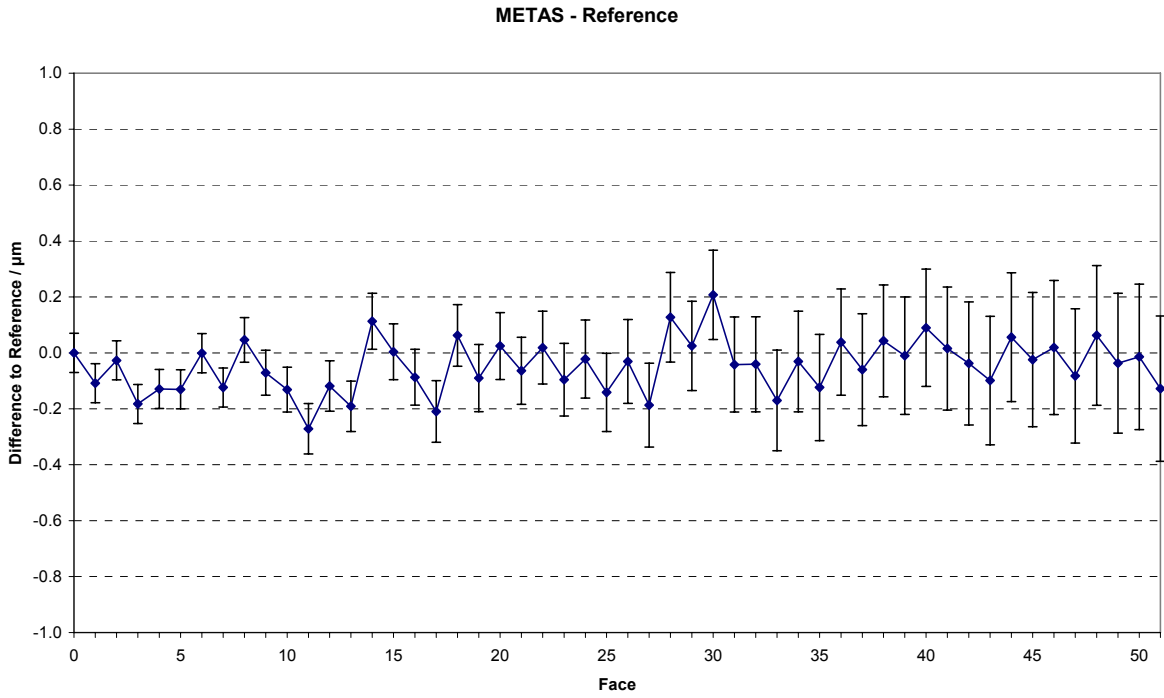

Fig. 10 : METAS step gauge data – Reference

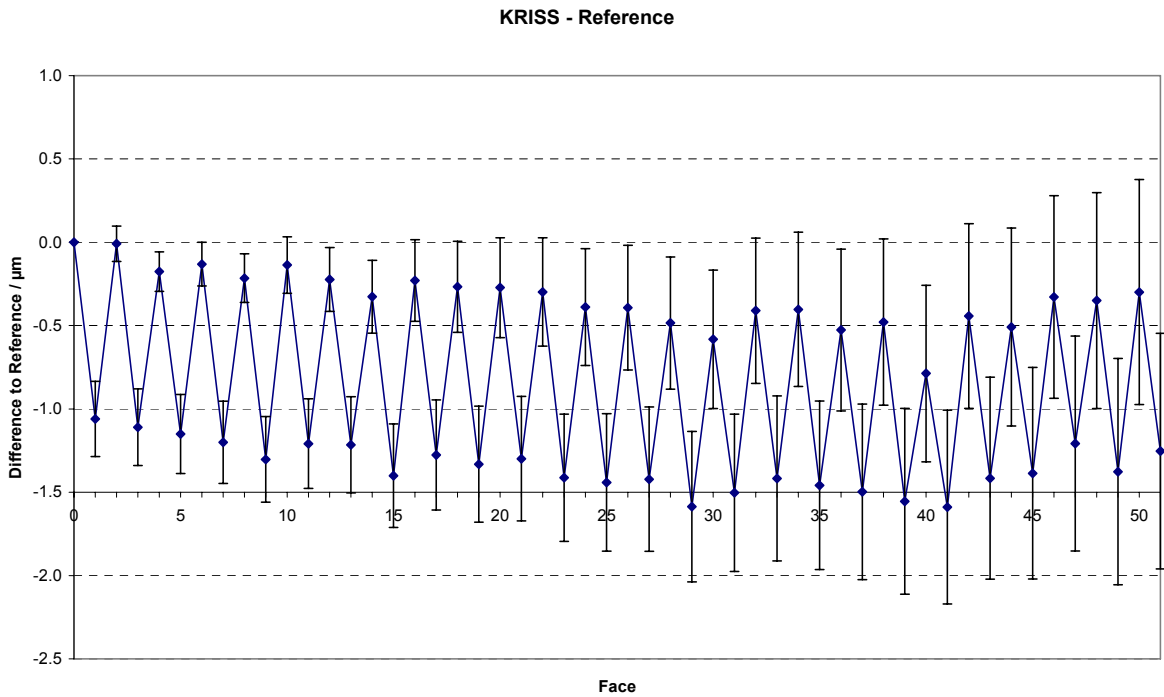

Fig. 11 : KRISS step gauge data - Reference

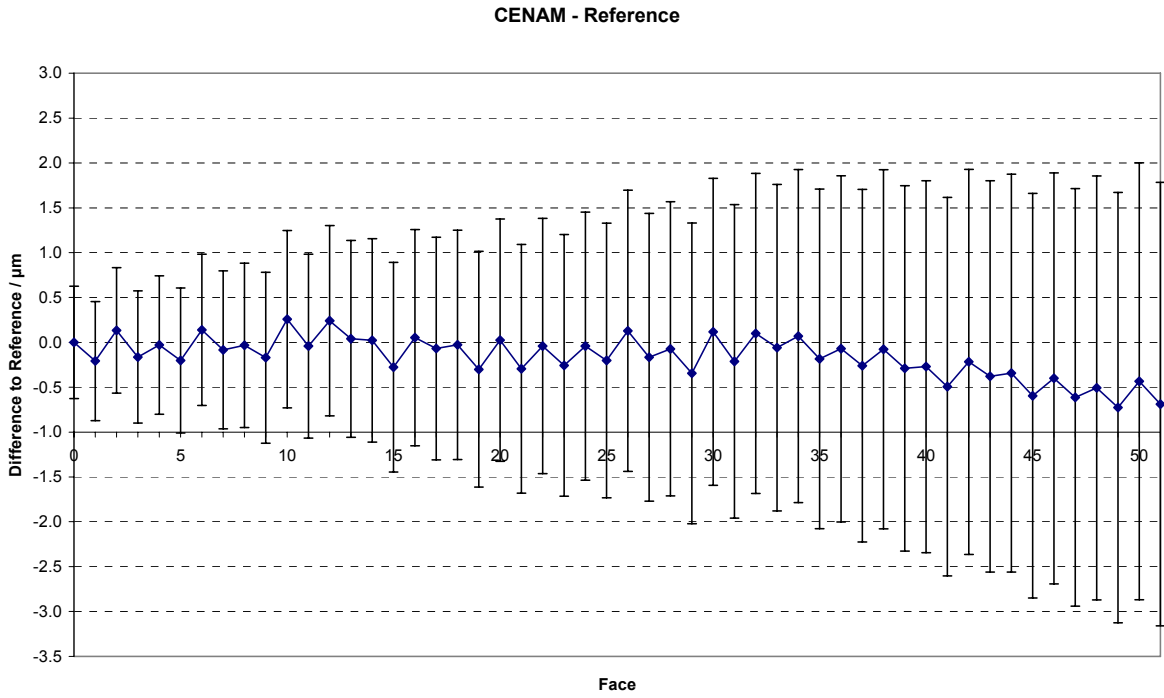

Fig. 12 : CENAM step gauge data – Reference

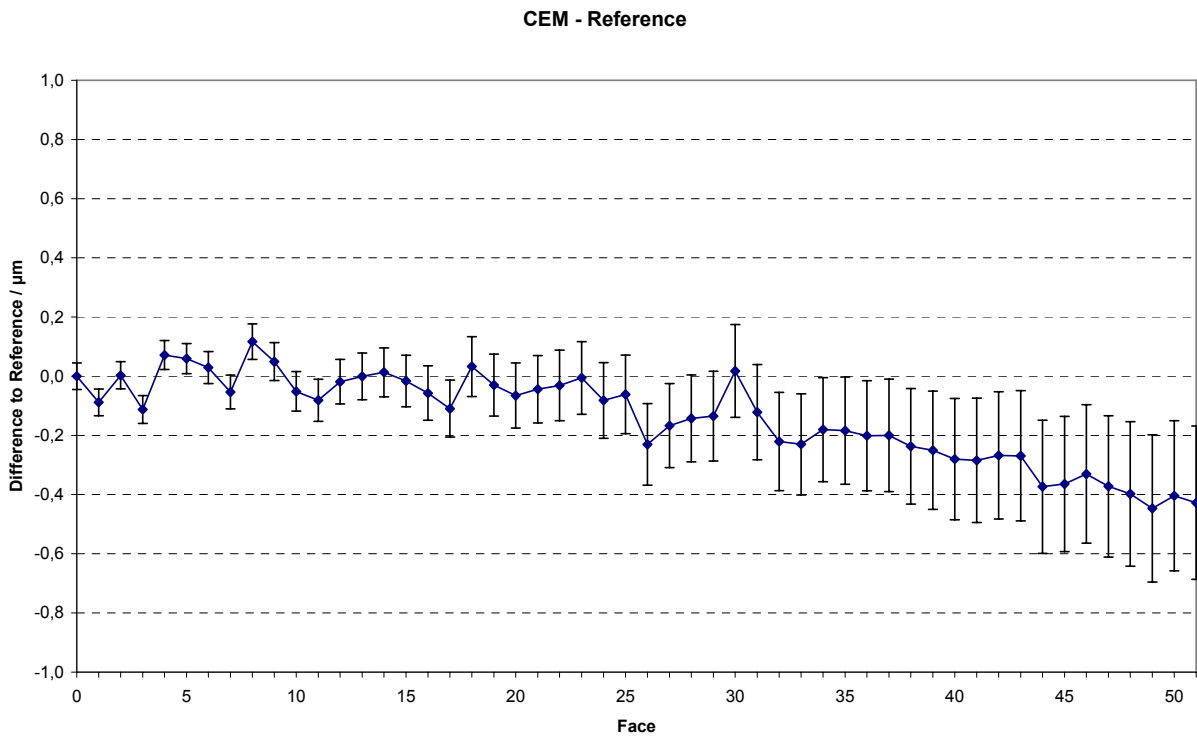

Fig. 13 : CEM step gauge data - Reference

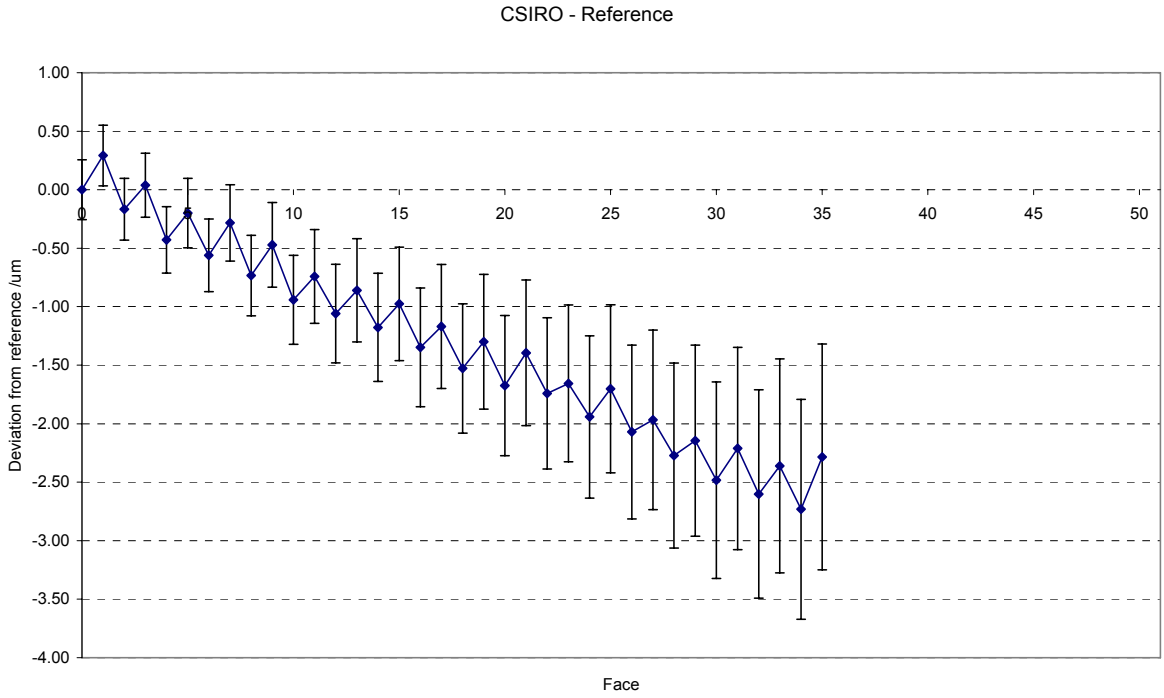

Fig. 14 :CSIRO step gauge data – Reference

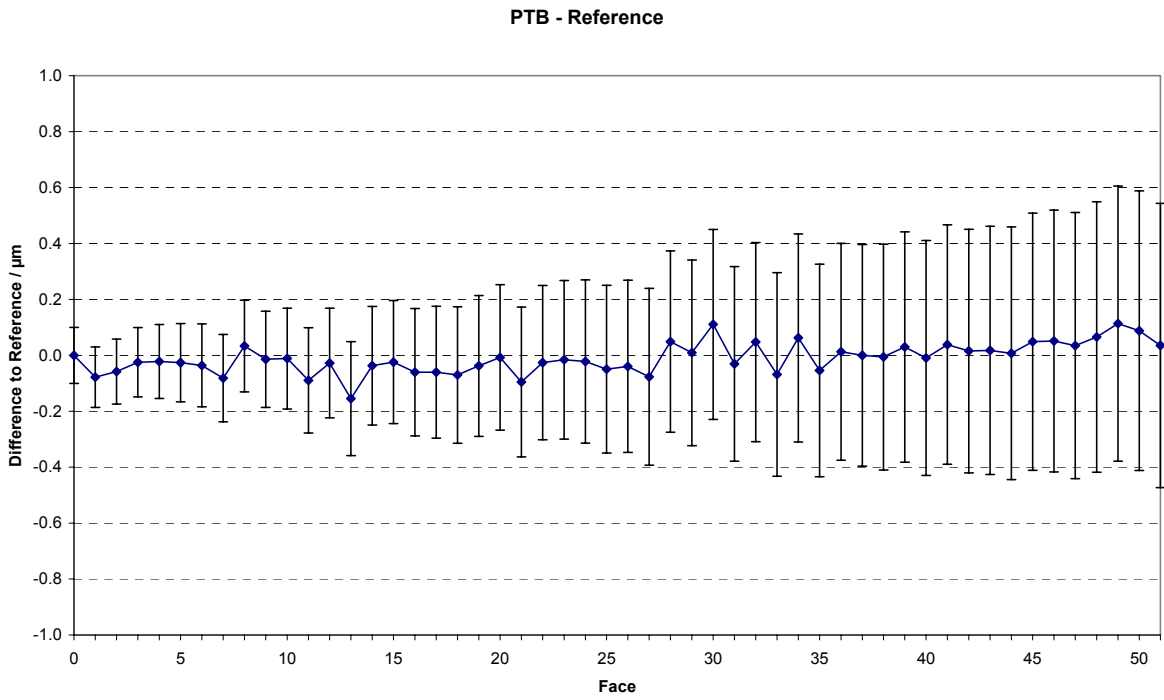

Fig. 15 : PTB step gauge data - Reference

8.3 Reference values for ball bar data

The mean of all available data was used to provide a reference value.

$$x_{ref} = \frac{1}{n} \sum_{j=1}^n x_j, \quad (5)$$

The uncertainty for the reference value is,

$$u(x_{ref}) = \frac{1}{n} \sqrt{\sum_{i=1}^n u^2(x_i)} \quad \text{for } n = 6 \text{ (Bar-#1) or } 4 \text{ (Bar-#2 \& Bar-#3)} \quad (6)$$

Artefact	Mean	Uncertainty
Bar-#1	4.82	0.19
Bar-#2	-10.29	0.29
Bar-#3	-2106.72	0.28

Table 9: Ball bar reference values and their uncertainties (μm)

8.4 Ball bar deviations from reference value

In 0 the resulting deviations from the reference is given. The values are additionally plotted in Fig. 16 to Fig. 18.

The uncertainty for the reference is given in Equation (4) with $n = 6$ (Bar-#1) or 4 (Bar-#2 & Bar-#3).

Artefact	PTB	KRISS	NMIJ	NIM	NIST	CSIRO
Bar-#1	0.29	-0.11	0.19	0.41	0.18	-0.94
Bar-#2	-0.02	0.46		-0.03	-0.40	
Bar-#3	1.02	-0.36		0.73	-1.38	

(a)

Artefact	PTB	KRISS	NMIJ	NIM	NIST	CSIRO
Bar-#1	1.05	1.06	0.96	0.50	0.47	0.90
Bar-#2	1.27	1.24		0.72	0.65	
Bar-#3	1.26	1.16		0.62	0.62	

(b)

Table 10: (a) Ball bar data deviation from the reference values and (b) the expanded uncertainty ($k=2$) of the deviation from the reference values (in μm)

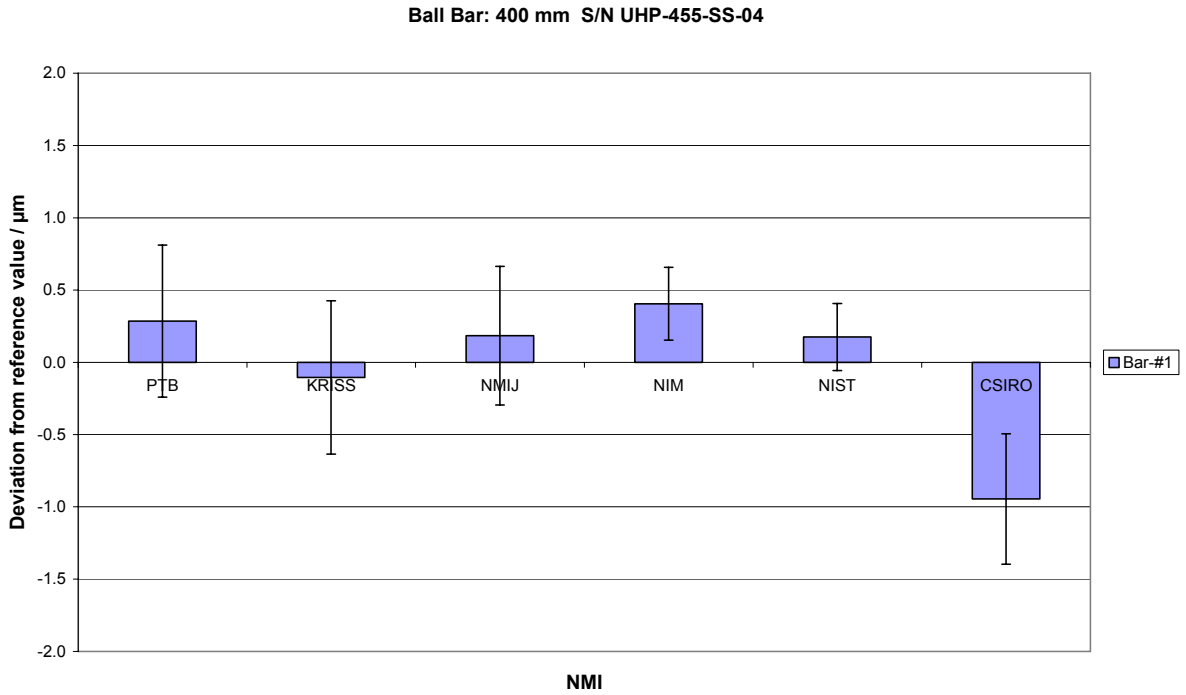

Fig. 16 :Ball bar #1 – Deviation from Reference

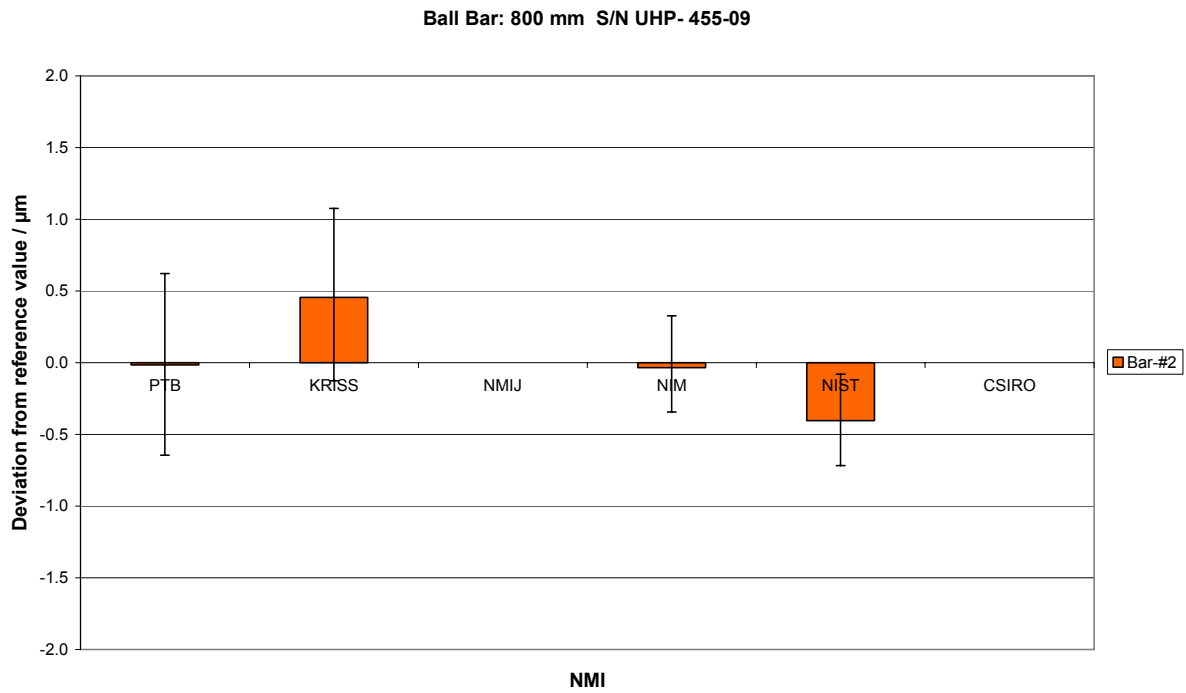

Fig. 17 : Ball bar #2 – Deviation from Reference

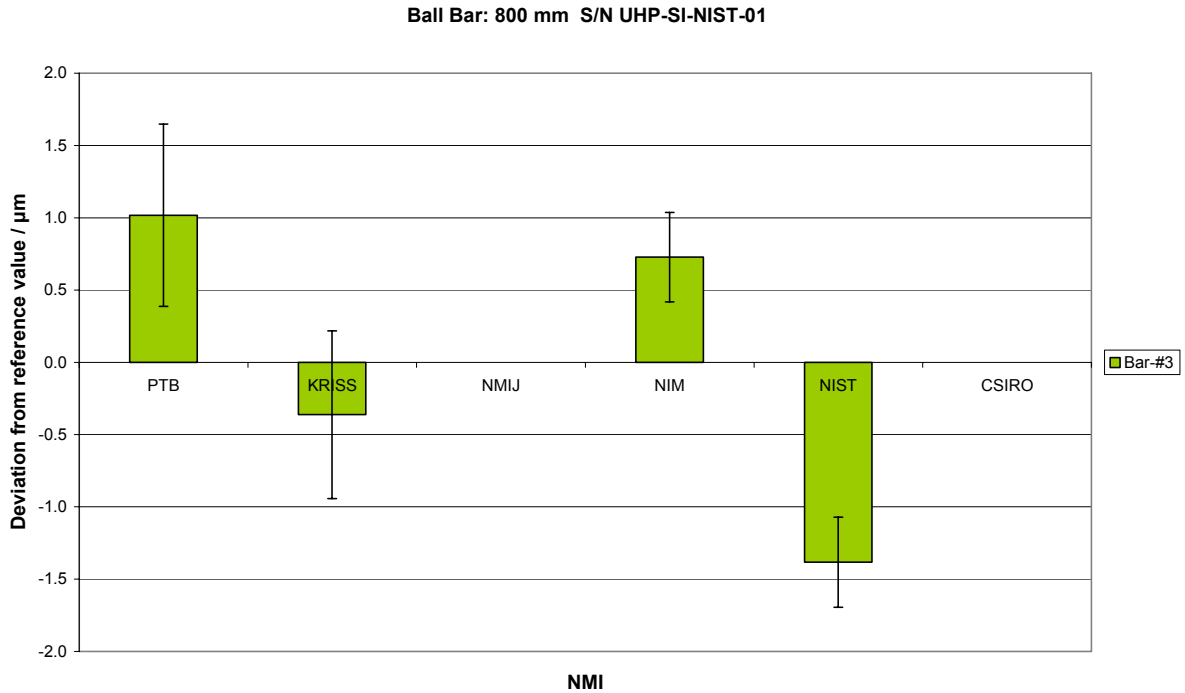

Fig. 18 : Ball bar #3 – Deviation from Reference

8.5 Definition of E_n

A check for statistical consistency of the results with their associated uncertainties can be made by calculating the E_n value for each laboratory. The E_n value is defined as [4]:

$$E_n = \frac{1}{k} \frac{x_{lab} - x_{ref}}{u(x_{lab} - x_{ref})} \quad (7)$$

Where x_{ref} is the comparison reference value and x_{lab} is the individual data value of a participant. The coverage factor is normally taken to be $k = 2$.

8.6 E_n – values

Table 10 lists the E_n values for the step gauge and Table 6 for the ball bars, calculated using the reference values given in 8.1 for the step gauge and 8.3 for the ball bar.

Face	PTB	CEM	CENAM	KRISS	METAS	NIM	NMIJ	NIST	CSIRO
0	0.00	0.00	0.00	0.00	0.00	0.00	0.00	0.00	0.00
1	0.39	0.57	0.16	2.26	0.67	0.93	0.46	0.26	1.13
2	0.27	0.02	0.09	0.04	0.16	0.08	0.13	0.21	0.63
3	0.11	0.68	0.11	2.31	1.08	1.03	0.43	0.32	0.14
4	0.09	0.41	0.02	0.63	0.74	0.30	0.27	1.14	1.51
5	0.11	0.33	0.12	2.31	0.72	0.93	0.36	0.13	0.68
6	0.14	0.15	0.08	0.43	0.01	0.14	0.02	0.13	1.80
7	0.30	0.27	0.05	2.31	0.65	0.96	0.33	0.33	0.87
8	0.12	0.56	0.02	0.64	0.23	0.08	0.14	0.10	2.13
9	0.05	0.23	0.09	2.40	0.34	0.52	0.13	0.12	1.30
10	0.04	0.23	0.13	0.35	0.61	0.32	0.20	0.23	2.47
11	0.27	0.35	0.02	2.12	1.19	0.58	0.43	0.64	1.85
12	0.08	0.08	0.11	0.52	0.51	0.36	0.05	0.45	2.52
13	0.44	0.00	0.02	1.99	0.81	0.76	0.37	0.62	1.95
14	0.10	0.05	0.01	0.68	0.45	0.39	0.14	0.03	2.54
15	0.06	0.06	0.12	2.13	0.01	0.71	0.01	0.05	2.01
16	0.15	0.20	0.02	0.43	0.33	0.32	0.03	0.45	2.66
17	0.15	0.37	0.03	1.82	0.76	0.72	0.20	0.53	2.21
18	0.17	0.11	0.01	0.45	0.22	0.06	0.10	0.21	2.77
19	0.09	0.09	0.11	1.81	0.31	0.64	0.08	0.26	2.26
20	0.02	0.20	0.01	0.42	0.08	0.37	0.12	0.17	2.80
21	0.21	0.13	0.11	1.65	0.21	0.44	0.11	0.29	2.24
22	0.06	0.09	0.01	0.43	0.06	0.51	0.13	0.27	2.69
23	0.03	0.02	0.09	1.75	0.30	0.22	0.01	0.31	2.47
24	0.04	0.22	0.01	0.52	0.07	0.37	0.10	0.31	2.80
25	0.10	0.16	0.07	1.66	0.41	0.15	0.08	0.39	2.37
26	0.08	0.58	0.04	0.49	0.09	0.41	0.06	0.30	2.79
27	0.14	0.41	0.05	1.56	0.52	0.05	0.15	0.44	2.57
28	0.09	0.34	0.02	0.57	0.34	0.56	0.23	0.03	2.87
29	0.02	0.31	0.10	1.66	0.07	0.08	0.10	0.09	2.63
30	0.19	0.04	0.03	0.66	0.54	0.27	0.27	0.31	2.95
31	0.05	0.27	0.06	1.51	0.10	0.13	0.01	0.20	2.56
32	0.08	0.48	0.03	0.44	0.10	0.59	0.09	0.15	2.92
33	0.11	0.48	0.02	1.36	0.41	0.09	0.09	0.41	2.58
34	0.10	0.37	0.02	0.41	0.07	0.77	0.13	0.16	2.91
35	0.08	0.37	0.05	1.36	0.28	0.27	0.03	0.36	2.37
36	0.09	0.30	0.01	0.46	0.20	0.75	0.18	0.01	
37	0.00	0.40	0.07	1.36	0.16	0.24		0.17	
38	0.01	0.47	0.02	0.46	0.12	0.85		0.11	
39	0.05	0.48	0.07	1.34	0.03	0.28		0.05	
40	0.01	0.53	0.06	0.71	0.23	0.83		0.22	
41	0.06	0.52	0.12	1.31	0.04	0.28		0.15	
42	0.02	0.48	0.05	0.38	0.09	0.89		0.06	
43	0.03	0.47	0.09	1.12	0.24	0.11		0.21	
44	0.01	0.65	0.08	0.41	0.13	0.92		0.16	
45	0.07	0.62	0.13	1.05	0.06	0.28		0.06	
46	0.07	0.55	0.09	0.26	0.04	0.99		0.18	
47	0.05	0.61	0.13	0.90	0.19	0.30		0.12	
48	0.09	0.64	0.11	0.26	0.14	1.13		0.32	
49	0.15	0.71	0.15	0.97	0.08	0.46		0.19	
50	0.11	0.62	0.09	0.21	0.03	1.16		0.18	
51	0.05	0.65	0.14	0.85	0.27	0.40		0.22	
Average	0.10	0.34	0.07	1.04	0.30	0.48	0.16	0.25	2.11

Table 11 : En values for step gauge data

Artefact	PTB	KRISS	NMIJ	NIM	NIST	CSIRO
Bar-#1	0.27	-0.10	0.19	0.80	0.38	-1.05
Bar-#2	-0.01	0.37		-0.05	-0.62	
Bar-#3	0.81	-0.31		1.18	-2.22	
mean	0.36	-0.01	0.19	0.64	-0.82	-1.05

Table 12 : En values for ball bar data

9 Conclusions

9.1 Step gauge data

The analysis shows that the step gauge was stable over time. As step gauges are non-monolithic standards with individual gauges, this is a very important condition for a comparison.

Most step gauge data agreed within the stated uncertainty. Some data sets, however, reveal typical problems of step gauge calibration, like an insufficient contacting ball calibration or a scale error. The given uncertainty of CENAM seems to be over-estimated.

The calculation of a stable reference needs some further discussion.

9.2 Ball bar data

The steel bars stayed stable in time. Most participants agreed within their uncertainty. The INVAR ball bar was possibly not stable in time. Despite of that most data values agree within their uncertainty. Therefore a systematic effect is hard to reveal. The significant difference between NIST's and PTB's data (of 2000) might be a hint towards a change.

The number of data values is too low to accurately calculate any statistic values.

9.3 Measurement procedures and uncertainty budgets

Not all laboratories reported on their individual measurement procedure, especially when custom-built machines were used. Uncertainty budgets were also supplied in some cases. As the measurement tasks in this comparison are quite simple, the budgets consist only of few components. So far no reference uncertainty budgets were developed. This would be difficult, because the measurement set-ups utilized in this comparison differ much more than for example in gauge-block comparisons.

10 References

- [1] A. Lewis, Final Report of CIPM Key Comparison CCL-K2, 2002
- [2] O. Jusko, Final Report of EUROMET Intercomparison #372, 1998
- [3] R. Thalmann, Final Report of CIPM Key Comparison CCL-K1, 2001
- [4] EA – 2/03 , EA Interlaboratory Intercomparison, <http://www.european-accreditation.org/>

APPENDIX A: Determination of the Key Comparison Reference Value.**Step Gauge**

The reference value used in this report has been adopted as the Key Comparison Reference Value. This followed discussions at the CCL/WGDM meeting in San Diego (2003, August, 2nd - 3rd) where it was agreed that in the interest of obtaining a result in a reasonable time, rather than wait while other methods were developed, this solution should be proposed to the participants for their approval.

The Key Comparison Reference Value has been taken as a simple mean of METAS, NMIJ, NIST, and PTB

$$x_{ref} = \frac{1}{n} \sum_{i=1}^n x_i, \quad (\text{A1})$$

where $j = \text{NMIJ, METAS, NIST, PTB}$, $n = 4$

with the uncertainty

$$u(x_{ref}) = \frac{1}{n} \sqrt{\sum_{i=1}^n u^2(x_i)} \quad (\text{A2})$$

Ball bars

The Key Comparison Reference Value was taken to be the simple average for all participants as there were no clear outliers in the results, so Equations A1 and A2 also apply in this case.

APPENDIX B: Step Gauge data analysed using constant and proportional components

OVERVIEW

This appendix analyses the data in a form which is more easily presented on the BIPM KCDB. It analyses the data into fixed and proportional parts by fitting a linear regression to the data.

Reported results: Measurements

The participant's reported values are shown in Table 2, (x_i) and can be resolved into constant (x_{ic}) and proportional (x_{ip}) parts by fitting a linear regression to the data. This is given by Equation.(A1) where l is the length of the gauge steps taken from the reference plane.

$$x_i = x_{ic} + x_{ip} * l \quad (B1)$$

This is a useful way of summarising the reported measurements.

Reported results: Uncertainty

The combined standard uncertainty was also reported as a table of values (Table 4), and fitting a linear regression will again obtain constant and proportional parts,

$$u_i = u_{ic} + u_{ip} * l \quad (B2)$$

A compact table of reported results and their uncertainties can then be displayed on the BIPM KCDB and this is shown in Table B1

MEASURAND: Relative positions of the gauge surfaces with respect to the centre of the front surface of the first gauge.

TRAVELLING STANDARD: A 1020 mm long step gauge with 51 steps

The result of measuring 51 gauges surfaces has been analysed into constant (x_{ic}) and proportional (x_{ip}) parts such that each measurement, $x_i = x_{ic} + x_{ip} * L$ where L is the interval length in mm.

The combined standard uncertainty $u_i = u_{ic} + u_{ip} * L$.

Measurement components <i>constant and proportional</i>				
Lab i ↓	Step Gauge: Serial number 871026/108			
	Constant component		Proportional component	
	x_{ic}	u_{ic}	x_{ip}	u_{ip}
	/μm	/μm	/μm/mm	/μm/mm
PTB	-4.56	0.10	1000.17377	0.00040
CEM	-4.41	0.03	1000.17322	0.00020
CENAM	-4.40	0.63	1000.17316	0.00181
KRISS	-5.12	0.11	1000.17325	0.00056
METAS	-4.58	0.05	1000.17375	0.00021
NIM	-4.22	0.18	1000.17288	0.00014
NMIJ	4.36	0.18	1000.14394	0.00048
NIST	-4.38	0.11	1000.17354	0.00010
CSIRO	5.55	0.08	1000.13503	0.00051

Table B1. Reported data and uncertainty for the KCDB

Key comparison reference value

Appendix 1 discusses the KCRV which is the mean value of four laboratories (Section 8.1). Values are listed in Table 6. Fitting a linear regression to these values and to the KCRV uncertainties (Table 8) provides a compact form for expressing the Equivalence statements.

Equation (B3) defines the KCRV (x_R) and Equation (B4) the uncertainty (u_R).

$$x_R = x_{Rc} + x_{Rp} * l \quad (B3)$$

$$u_R = u_{Rc} + u_{Rp} * l \quad (B4)$$

MEASURAND: Relative positions of the gauge surfaces with respect to the centre of the front surface of the first gauge.

TRAVELLING STANDARD: A 1020 mm long step gauge with 51 steps.

The key comparison reference value x_R is obtained by taking a mean of the results reported by PTB, METAS, NMIJ & NIST. A linear regression was then fitted to obtain the constant and proportional parts such that $x_R = x_{Rc} + x_{Rp} * L$, where L is the interval length (mm).

The combined standard uncertainty is given by $u_R = u_{Rc} + u_{Rp} * L$.

Measurement components *constant and proportional*

Step Gauge: Serial number 871026/108			
Constant component		Proportional component	
x_{Rc}	u_{Rc}	x_{Rp}	u_{Rp}
/μm	/μm	/μm/mm	/μm/mm
-4.490	0.065	1000.17366	0.00014

Table B2: The Equivalence statement required for the BIPM KCDB

Degrees of Equivalence

The degrees of equivalence are shown in Table 7. Fitting a linear regression to this data will provide information on the scale factor for each participant. This can be directly related to the proportional part of their uncertainty. It should be noted that the proportional parts for the data (x_{ip} in Equation A1) includes any proportional errors in the length of the artefact, while the deviation from the reference value data does not, because these errors are also present in the KCRV so they cancel out.

The fixed component should not be taken as the constant part because it is unduly influenced by the measurement of the zero reference surface of the step gauge and the subsequent scatter in values can

be both positive and negative, leaving an average offset which can be close to zero. Subtracting the linear regression from the original data to remove the trend yet leave the experimental scatter isolates this component. Calculating a standard deviation for this scatter then provides a suitable fixed component (see report on CCL supplementary comparison nano-3 by H. Bosse, where this technique was used for line scales).

The first step is to fit a linear regression to the Degrees of Equivalence given in Table 7, to get Equation (B5).

$$D_i = D_{ic} + D_{ip} * l \quad (B5)$$

This is then subtracted from the data to obtain residuals D_{iRes}

$$D_{iRes} = (x_i - x_R) - (D_{ic} + D_{ip} * l) \quad (B6)$$

The constant part in Eq.(A5) is then replaced by the standard deviation of D_{iRes} , multiplied by $\sqrt{2}$ to obtain the uncertainty of an interval rather than a single measurement point. Taking these two components and combining them gives Equation B7 for the Degrees of Equivalence.

$$D_i = \sqrt{2} \cdot u(D_{iRes}) + D_{ip} * l \quad (B7)$$

The expanded uncertainty ($k=2$) for the Degrees of equivalence can be obtained by fitting linear regressions to the values in Table 8.

$$U_i = U_{ic} + U_{ip} * l \quad (B8)$$

MEASURAND: Relative positions of the gauge surfaces with respect to the centre of the front surface of the first gauge.

TRAVELLING STANDARD: A 1020 mm long step gauge with 51 steps.

Degrees of equivalence have been analysed into constant D_{ic} and proportional D_{ip} terms with expanded uncertainties (coverage factor: 2) U_{ic} and U_{ip} , for each laboratory i , with respect to the reference value for each gauge surface.

Measurement components <i>constant and proportional</i>				
Lab i ↓	Step Gauge: Serial number 871026/108			
	Constant component		Proportional component	
	D_{ic}	U_{ic}	D_{ip}	U_{ip}
	/μm	/μm	/μm/mm	/μm/mm
PTB	0.06	0.20	0.00011	0.00058
CEM	0.10	0.13	-0.00043	0.00048
CENAM	0.25	1.26	-0.00050	0.00363
KRISS	0.74	0.26	-0.00040	0.00113
METAS	0.13	0.16	0.00009	0.00032
NIM	0.32	0.39	-0.00077	0.00038
NMIJ	0.12	0.28	-0.00021	0.00075
NIST	0.10	0.22	-0.00011	0.00022
CSIRO	0.24	0.19	-0.00389	0.00107

Table B3: Degrees of Equivalence

MEASURAND: Relative positions of the gauge surfaces with respect to the centre of the front surface of the first gauge.

TRAVELLING STANDARD: A 1020 mm long step gauge with 51 steps.

Degrees of equivalence have been analysed into constant D_{ic} and proportional D_{ip} terms with expanded uncertainties (coverage factor: 2) U_{ic} and U_{ip} , for each laboratory i , with respect to the reference value for each gauge surface.

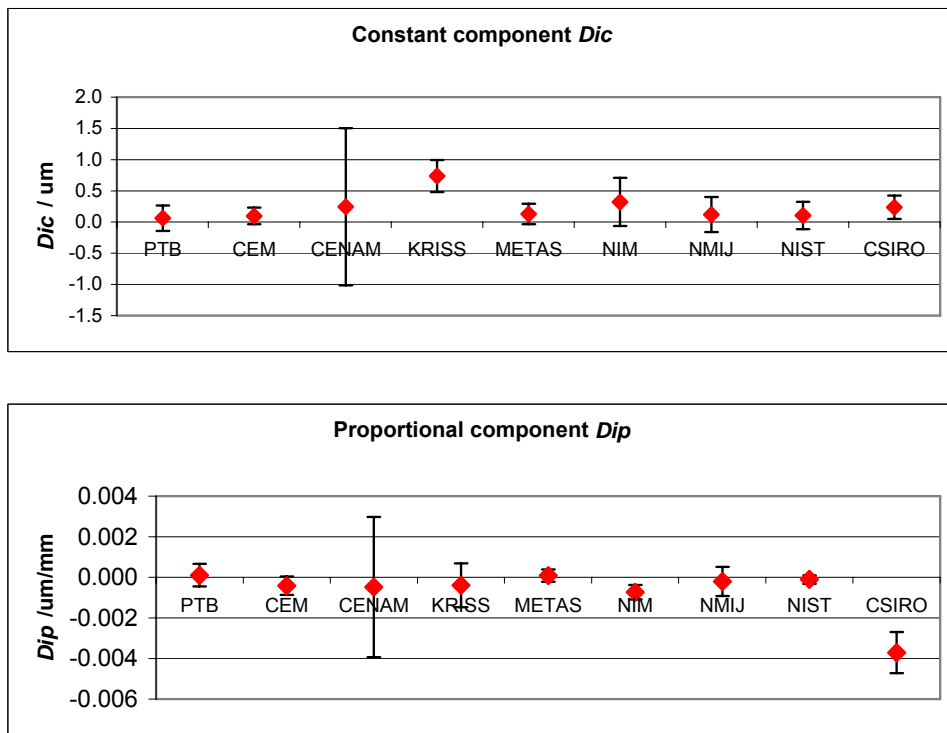

Table B4: Degrees of Equivalence as a graph

Appendix C: Ball bar tables for KCDB

Laboratory individual measurements

MEASURAND: The length between the ball centres of each ball bar. Ball bar material was steel, steel and super invar

NOMINAL VALUES: 400 mm, 800 mm (Steel) and 800 mm (Super Invar)

x_{ik} : result of measurement carried out by laboratory i for ball bar k with nominal length L_k , expressed as the deviation from nominal length in μm

u_{ik} : combined standard uncertainty of x_{ik} reported by laboratory i

		Nominal length L_k ($k = 1$ to 3) →					
		400 mm		800 mm		800 mm	
		S/N UHP-455-SS-04		S/N UHP-455-09		S/N UHP-SI-NIST-01	
Lab i ↓	$x_{i1} / \mu\text{m}$	$u_{i1} / \mu\text{m}$	$x_{i2} / \mu\text{m}$	$u_{i2} / \mu\text{m}$	$x_{i3} / \mu\text{m}$	$u_{i3} / \mu\text{m}$	
PTB	5.10	0.60	-10.30	0.80	-2105.70	0.80	
KRISS	4.71	0.61	-9.83	0.77	-2107.08	0.72	
NMIJ	5.00	0.54					
NIM	5.22	0.20	-10.32	0.30	-2105.99	0.19	
NIST	4.99	0.16	-10.69	0.20	-2108.10	0.20	
CSIRO	3.87	0.50					

Table C1: Laboratory individual results

Equivalence statements

MEASURAND: The length between the ball centres of each ball bar. Ball bar material was steel, steel and super invar

NOMINAL VALUES: 400 mm, 800 mm (Steel) and 800 mm (Super Invar)

The CCL key comparison reference value, x_{Rk} , for each ball bar k is obtained from the mean x_{mk} of the participants' values x_{jk} by adding a constant C_k chosen such that the reference value is the nominal length: $x_{Rk} = L_k = x_{mk} + C_k$.

The standard uncertainty u_{Rk} of x_{Rk} is obtained from the reported standard uncertainties u_{mk} .

Nominal length L_k ($k = 1$ to 3) →						
400 mm		800 mm		800 mm		
S/N UHP-455-SS-04		S/N UHP-455-09		S/N UHP-SI-NIST-01		
	$x_{m1} / \mu\text{m}$	$u_{m1} / \mu\text{m}$	$x_{m2} / \mu\text{m}$	$u_{m2} / \mu\text{m}$	$x_{m3} / \mu\text{m}$	$u_{m3} / \mu\text{m}$
Mean $x_{mk} / \mu\text{m}$	4.82	0.19	-10.29	0.29	-2106.72	0.28

Table C2: Equivalence statements

Degrees of equivalence

MEASURAND: The length between the ball centres of each ball bar. Ball bar material was steel, steel and super invar

NOMINAL VALUES: 400 mm, 800 mm (Steel) and 800 mm (Super Invar)

Degrees of equivalence, D_i and expanded uncertainty U_i for each nominal length

		Nominal length L_k ($k = 1$ to 3) →					
		400 mm		800 mm		800 mm	
Lab l ↓		S/N UHP-455-SS-04		S/N UHP-455-09		S/N UHP-SI-NIST-01	
		$D_{i1} / \mu\text{m}$	$U_{i1} / \mu\text{m}$	$D_{i2} / \mu\text{m}$	$U_{i2} / \mu\text{m}$	$D_{i3} / \mu\text{m}$	$U_{i3} / \mu\text{m}$
PTB		0.29	1.05	-0.02	1.27	1.02	1.26
KRISS		-0.11	1.06	0.46	1.24	-0.36	1.16
NMIJ		0.19	0.96				
NIM		0.41	0.50	-0.03	0.72	0.73	0.62
NIST		0.18	0.47	-0.40	0.65	-1.38	0.62
CSIRO		-0.94	0.90				

Table C3: Degrees of equivalence

Degrees of equivalence: Graphs

MEASURAND: The length between the ball centres of each ball bar. Ball bar material was steel, steel and super invar

NOMINAL VALUES: 400 mm, 800 mm (Steel) and 800 mm (Super Invar)

Degrees of equivalence, D_i and expanded uncertainty U_i for each nominal length

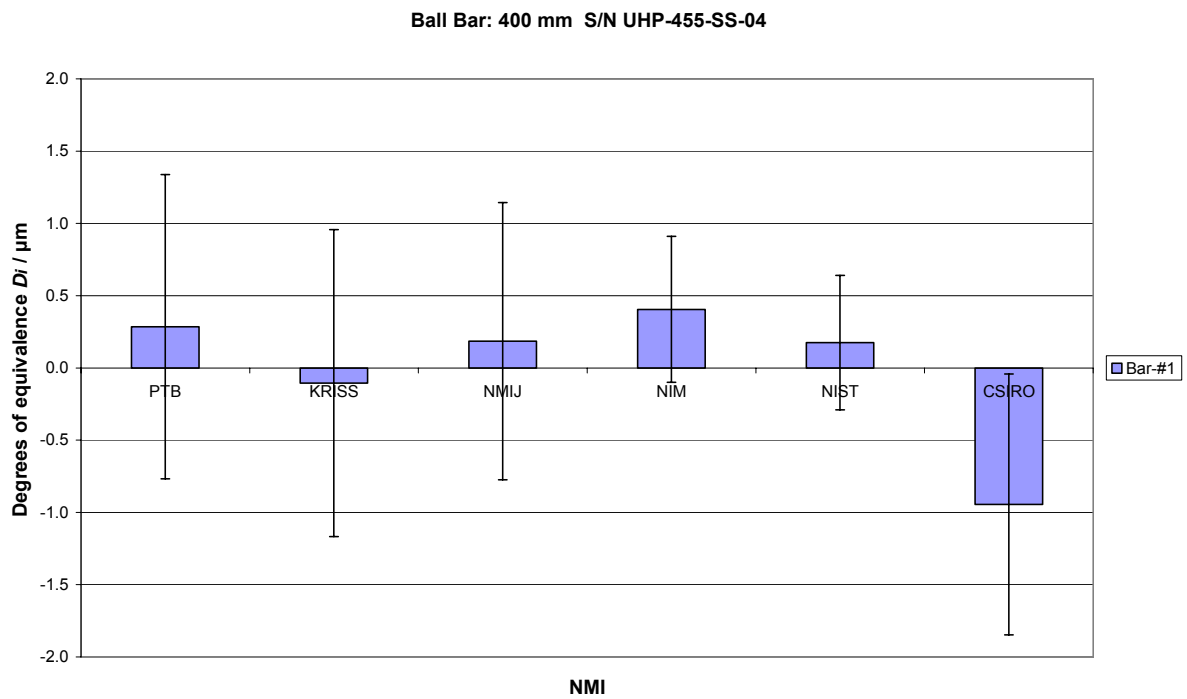

Ball Bar: 800 mm S/N UHP- 455-09

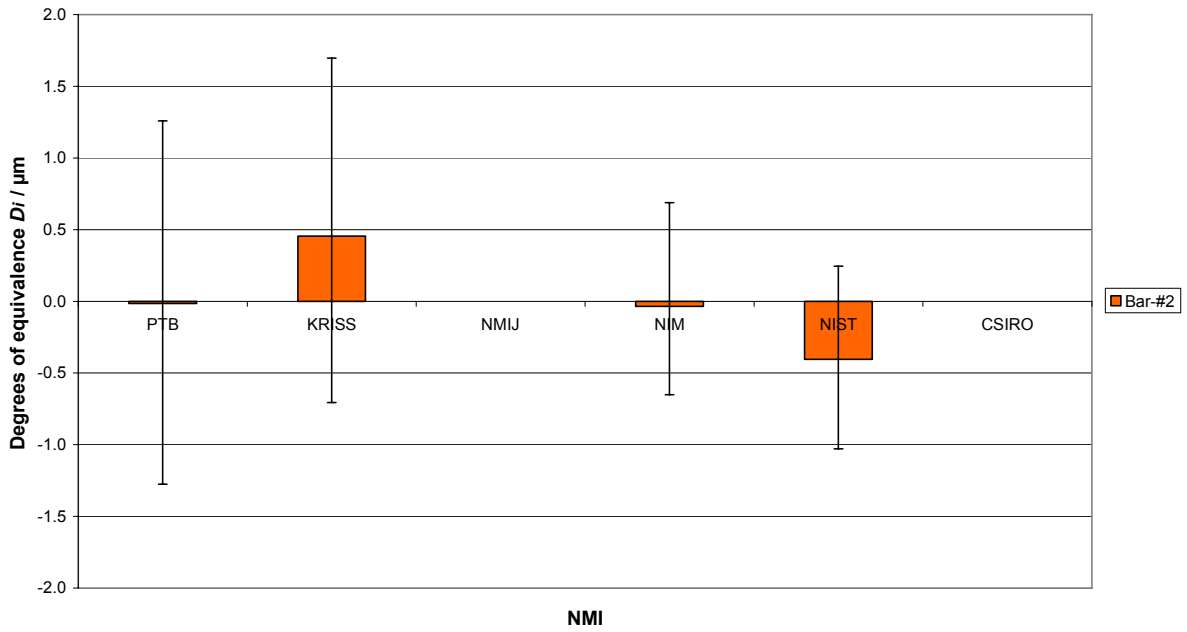

Ball Bar: 800 mm S/N UHP-SI-NIST-01

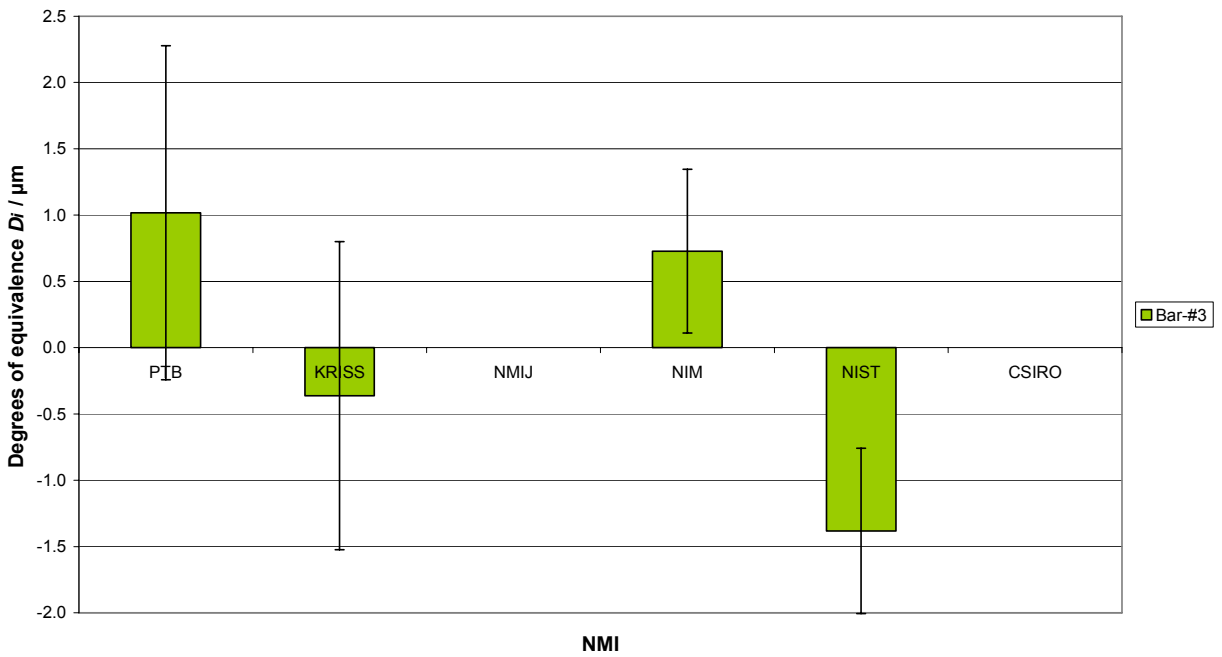

Appendix added by Nick Brown (chair WGDM) – 10 May 2006