

Report on
the EUROMET-PR Key
Comparison K6

Spectral regular transmittance

LNE-INM – June 2010
G. Obein
J. Bastie

1. Introduction

In October 1999 thirty-eight Member States of the Metre Convention and representatives of two international organisations signed the Mutual Recognition Arrangement (MRA)¹. Now the list of signatories of the Mutual Recognition Arrangement has 45 Members States, 20 Associates of the CGPM and 2 international organisations. A particular aspect of the MRA is the organisation of international comparisons of measurements, to be known as key comparisons. They are introduced, organised and processed according to guidelines which ensure the equivalence of values assigned to transfer standards by different National Metrological Institutes (NMIs).

At the 14th CCPR-meeting in June 1997, it was decided to carry out a Key Comparison of spectral regular transmittance. For the preparation of this comparison a working group with Helsinki University of Technology (HUT, at the present time MIKES), Measurement Standards Laboratory of New Zealand (MSL), National Institute of Standards and Technology (NIST), National Physical Laboratory (NPL), Physikalisch-Technische Bundesanstalt (PTB) and Bureau National de Métrologie (BNM-INM, at present time LNE-INM) was formed, with the LNE-INM acting as the central and reporting laboratory for the measurements to be done and co-operating closely with the BIPM.

In order to link to the CIPM key comparisons the laboratories which are not participating in the key comparison organised by the Consultative Committee of the CIPM it has been decided to organise the same comparisons within the Regional Metrology Organisations. These comparisons have to include at least two laboratories which have taken part in the same CIPM key comparisons. The EUROMET project 538 “Comparison of spectral regular transmittance” in charge of doing the link between the European laboratories and the CCPR key comparison has been started in April 1999 with the LNE-INM (France) acting as pilot laboratory. It was decided to use exactly the same technical protocol as for the CCPR key comparison.

2. Participants

The EUROMET project proposal 538 “Key-Comparisons of spectral regular transmittance (EUROMET.PR-K6)” was dispatched in April 1999 to the EUROMET-PR members. Seventeen laboratories agreed to join this project. They are listed in Table 1. Among these seventeen laboratories, seven have participated in the CCPR-K6 key comparison. At the EUROMET Contact Person meeting in April 2000, in Istanbul, it was decided to have the link between the CCPR K6 comparison and the EUROMET K6 comparison using the results of all the European laboratories which have taken part in the CCPR K6 comparison but without new measurements. These laboratories are identified in Table 1 with a grey background. This is possible because the comparison is running approximately at the same time and with the same pilot laboratory which

¹ Mutual recognition of national measurement standards and of calibration and measurement certificates issued by national metrology institutes

Paris, 14 October 1999

Comité international des poids et mesures

Édité par le BIPM

Pavillon de Breteuil

F-92312 Sèvres Cedex, France

Imprimerie STEDI (Paris)

Achevé d'imprimer : septembre 1999

has measured all the sets of filters in exactly the same conditions and the technical protocols for both comparisons are identical.

The protocol was sent out to the ten new participants on 5 February 2001 and is reproduced in full (with slight edits) in Annex A.

Table 1 – List of the participating laboratories to the EUROMET-PR-K6 comparison.²

Acronym	Laboratory Name	Country
BEV	Bundesamt für Eich- und Vermessungswesen Gruppe Eichwesen	Austria
<i>BNM-INM</i> → LNE-IMN	<i>Bureau National de Métrologie - Institut National de Métrologie</i> Laboratoire National de métrologie et d'Essais	France
<i>CETO*</i> → IPQ	<i>Centro de Ciências e Tecnologias Ópticas, Universidade do Porto</i> Instituto Português da Qualidade	Portugal
CMI	Czech Metrology Institute	Czech Republic
GUM	Główny Urząd Miar	Poland
<i>HUT</i> → MIKES	<i>Helsinki University Of Technology</i> Centre for Metrology and Accreditation	Finland
<i>IEN</i> → INRIM	<i>Istituto Elettrotecnico Nazionale Galileo Ferraris</i> Istituto Nazionale di Ricerca Metrologica	Italy
IFA	Instituto de Física Aplicada	Spain
INM	Institutul National de Metrologie	Romania
METAS	Swiss Federal Office of Metrology	Switzerland
<i>NMi</i> → VSL	<i>Nederlands Meetinstituut</i> Van Swinden Laboratorium	The Netherlands
NPL	National Physical Laboratory	UK
<i>OMH</i> MKEH	Országos Mérésügyi Hivatal Magyar Kereskedelmi és Engedélyezési Hivatal	Hungary
PTB	Physikalisch-Technische Bundesanstalt	Germany
SMU	Slovensky Metrologický Ústav	Slovakia
SP	Swedish National Testing and Research Institute	Sweden
UME	Ulusal Metroloji Enstitüsü	Turkey

For laboratories having changed their name, the new name will be used in this report.

The laboratories in grey cells are the laboratories which have taken part in the CCPR K6 comparison and which are doing the link between both comparisons.

* CETO has been closed and its activities transferred to IPQ, Instituto Português da Qualidade.

² When the laboratory name or the acronym has changed during the time of the key comparison, the first line, *written in italic*, is the name of the lab at the beginning of the comparison, the current name is written under, in regular font.

In some laboratories the contact person in charge of the comparison has also changed between the beginning and the end of the comparison. In some other cases the address of the contact person has changed. Also the participant information given in the technical protocol (Annex A) has to be updated according to the information contained in the table below.

Table 2 – List updated in September 2008 of the contact persons for the participating laboratories to the EUROMET-PR-K6 comparison.

BEV	Dr Peter Rosenkranz Bundesamt für Eich- und Vermessungswesen Gruppe Eichwesen Arltgasse 35 1160 Wien Austria	Phone : +43 1 49 110 540 Fax : +43 1 49 20 875 E-mail : Peter.rosenkranz@bev-eich.gv.at
CMI	Dr Marek Smid Czech Metrology Institute Laboratory of Fundamental Metrology V botanic 4 150 72 Praha 5 Czech Republic	Phone : +420 2 5731 98 30 Fax : +420 2 5732 80 77 E-mail : msmid@cmi.cz
GUM	Dr Lukasz Litwiniuk Central Office of Measures Główny Urząd Miar 00-950 Warszawa P.O. Box 10 ul. Elektoralna 2 Poland	Phone : +48 22 620 59 71 Fax : +48 22 620 83 78 Radiation@gum.gov.pl
IFA	Dr Alicia Pons CSIC - Instituto de Fisica Aplicada C/Serrano 144 28006 Madrid Spain	Phone : + 34 91 561 8806 Fax : + 34 91 411 7651 E-mail : apons@ifa.cetef.csic.es
INM	Dr Mihai Simionescu Institutul National de Metrologie Sos. Vitan –Bârzesti 11 Sector 4 Bucuresti 042122 Roumanie	Phone : +40-1-334 50 60 Fax : +40-1-334 53 45 E-mail : mihai.simionescu@inm.ro
INRIM	Ing Giuseppe Rossi INRIM Strada delle Cacce, 91 10135 Torino Italy	Phone : + 39 011 39 19 226 Fax : + 39 011 34 63 84 E-mail : g.rossi@inrim.it

IPQ	Dr Olivier Pellegrino Laboratório de Fotometria, Radiometria e Radiofrequências Laboratório Central de Metrologia Instituto Português da Qualidade Rua António Gião, 2 2829-513 Caparica Portugal	Phone : +351 212 948 179 Fax : +351 212 948 188 E-mail : opellegrino@mail.ipq.pt
LNE-INM	Dr Gaël Obein LNE-INM 61, rue du Landy 93210 La Plaine Saint-Denis France	Phone : +33 1 58 80 87 88 Fax : +33 1 58 80 89 00 E-mail : gael.obein@cnam.fr
METAS	Dr Peter Blattner Swiss Federal Office of Metrology Lindenweg 50 3003 Bern-Wabern Switzerland	Phone : +41 31 32 33 340 Fax : +41 31 32 33 210 E-mail : peter.blattner@ofmet.admin.ch
MIKES	Dr Farshid Manoocheri MIKES - Metrology Research Institute Otakaari 5 A PO Box 3000 FI-02015 TKK Finland	Phone : + 358 9 451 2337 Fax : + 358 9 451 2222 E-mail : farshid.manoocheri@tkk.fi
MKEH	Dr George Andor National Office of Measures, Optical section Németrolgyi ut 37 – 39 Budapest H – 1124 Hungary	Phone : + 36 1 45 85 833 Fax : + 36 1 214 3157 E-mail : gdezsi@omh.hu
NPL	Dr Christopher Chunnillall NPL Hampton Road Teddington Middlesex TW11 0LW United Kingdom	Phone : + 44 20 8943 6872 Fax : + 44 20 8943 6935 E-mail : chris.chunnillall@npl.co.uk
PTB	Dr Alfred Schirmacher PTB – AG 4.51 Speltrometrie und mikrooptische Messtechnik Bundesallee 100 D – 38116 Braunschweig Germany	Phone : + 49 531 592 4510 Fax : + 49 531 592 4272 or 9292 E-mail : alfred.schirmacher@ptb.de
SMU	Dr Marta Obenrauchova SMU – Chemistry centre Karloveska 63 842 55 Bratislava Slovakia	Phone : + 421 2 602 94 228 Fax : + 421 2 602 94 561 E-mail : obenrauchova@smu.gov.sk

SP	Dr Anne Andersson-Fäldt Swedish National Testing and Research Institute P.O. Box 857 501 15 Boras Sweden	Phone : +46 33 16 54 03 Fax : +46 33 16 56 20 E-mail : anne.afaldt@sp.se
UME	Dr Kamuran Turkoglu Ulusal Metroloji Enstitüsü TUBITAK-UME PO Box 54 41470 Gebze, Kocaeli Turkey	Phone : + 90 262 679 5000, ext : 3353 Fax : + 90 262 679 5001 E-mail : akt@ ume.tubitak.gov.tr
VSL	Dr Eric van der Ham Van Swinden Laboratorium Temperature and radiation PO Box 654 2600 AR Delft The Netherlands	Phone : + 31 15 2691500 Fax : + 31 15 2612 971 E-mail : evdham@nmi.nl

3. Principle of the comparison

The comparison was organised in the same way as the corresponding CCPR-K6 key comparison:

- * The aim of this first key comparison in this field was restricted to check only the accuracy of the photometric scale of the reference spectrophotometers of National Metrological Institutes.
- * The comparison will be a star type comparison with the samples provided by the pilot laboratory and sent out to all the participants at the same time.
- * The filters will be coloured glass filter plates 50 mm × 50 mm.
- * The nominal transmittances will be approximately 92%, 56%, 10%, 1% and 0.1%.
- * The wavelengths of measurement should be (380, 400, 500, 600, 700, 800, 900 and 1000) nm.
- * The recommended geometry will be a parallel beam with a circular shape of 20 mm diameter or a square shape of 20 mm side.
- * The angle of incidence should be normal or near normal.
- * The recommended bandwidth will be 1 nm.

3.1. Description of the standards

The filter set to check the photometric scale comprises five neutral-coloured glass filter plates 50 mm x 50 mm with nominal transmittance, at the wavelength of 546 nm, of approximately 92%, 56%, 10%, 1% and 0.1%. Each filter is identified by a reference engraved in a corner outside the area used for measurement. This reference has two parts. One is a letter indicating the type of glass (see table below) the other is the serial number of the filter. The main characteristics of the filters are summarised in the following Table 3:

Table 3 – Filter characteristics.

Nominal transmittance @ 546 nm in %	Type of glass	Nominal thickness mm	Reference
92	BK 7	4.0	A
56	NG 11	1.5	B
10	NG 5	3.9	C
1	NG 4	3.9	D
0.1	NG 3	3.1	E

The manufacturing tolerances are for :

Size : 50 x50 (+0/-0.3) mm

Flatness : better than 5 μm over a central diameter of 30 mm

Parallelism : better than 0.02 mm except for the filter of transmittance 92% (<0.1 mm)

The delivery of 30 sets of filters arrived at the end of July 1999 and measurements started in September of the same year on 20 sets for the CCPR comparison. Immediately after completion of the measurements for the CCPR-K6 comparison the measurement for the EUROMET-PR-K6 comparison started on filter sets number 21 to 30. The measurements took place from the beginning of April to the end of May 2000 with some extra measurements for checking potential drift behaviour in January 2001.

3.2. Measurements before dispatching

At the pilot laboratory, measurements before dispatching the filters have been carried out on the reference spectrophotometer of the laboratory. The complete description of the experiment is detailed in the following paragraph.

3.3. LNE-INM experimental set-up

Facility

The LNE-INM reference spectrometer for transmittance measurements is composed primarily of a source, a monochromator, an optical mount and a detector (Figure 1). The QTH lamp is used on the full spectral range from 380 to 1000 nm. The image of the filament is formed at the entrance slit of the monochromator with two lenses. Between the lenses, where the beam is collimated, non-fluorescent filters are used to suppress higher orders. These filters are coloured filters from the SFK filter collection, from Schott. They are band pass filters with a half width at half the maximum ranging between 25 nm to 60 nm. To reduce the “in band” straylight, the aperture is adjusted to avoid having light outside the grating. The “out band” stray was checked using long pass, sharp cut-off, coloured glass filters at various wavelengths.

The wavelength is controlled by a high resolution Jobin Yvon single grating monochromator. The focal distance of the spherical mirrors of the Czerny-Turner mount is 1500 mm and the numerical aperture is F/12. For the spectral range 380 nm to 700 nm, the grating is a holographic grating with 2000 grooves per mm giving a band pass of 0.5 nm at the exit slit of the monochromator. For the spectral range 700 nm to 1000 nm, the grating is an engraved grating with 1200 grooves per mm giving a band pass of 0.8 nm. The resolution obtained with the stepper motor is 0.002 nm with the holographic grating and better than 0.0035 nm between 800 and 1400 nm.

Two spherical mirrors are used to relay the light to the detector and avoid chromatic aberrations and back reflections. Between the mirrors, the light beam is collimated and goes through the filter to be measured. The beam spot on the filters was a 20 mm diameter circle as recommended in the

protocol. The filter holder is mounted on a translation stage, to allow the measurement of the reference beam (100%) and the signal when the beam is stopped (0%). The detector part is composed of an integrating sphere and a detector. The detector is associated with the grating. For the holographic grating, in the visible range, a photomultiplier S20 is used. For the ruled grating, in the IR range, a silicon photodiode is used. All the optical mounts at the exit slit of the monochromator are housed in a temperature-controlled black box. For the “before” measurements, the average temperature in the box was $22 \pm 1 \text{ }^\circ\text{C}$; for the “after” measurements the average temperature in the box was $22.5 \pm 0.6 \text{ }^\circ\text{C}$. Filter sets “D” and “E” have been measured using a step down method with an NG 5 filter in the reference beam. The transmittance of this filter was approximately 10%. For each filter and each wavelength, a set of three successive measurements was taken and the mean value and the standard deviation were calculated. A second set of measurements identical to the first one was taken on another day. If one of the standard deviations was larger than the expected value or the discrepancy between both measurements was too large, a third and in some cases a fourth set of measurements was taken. The final result is the mean of at least two sets of measurements.

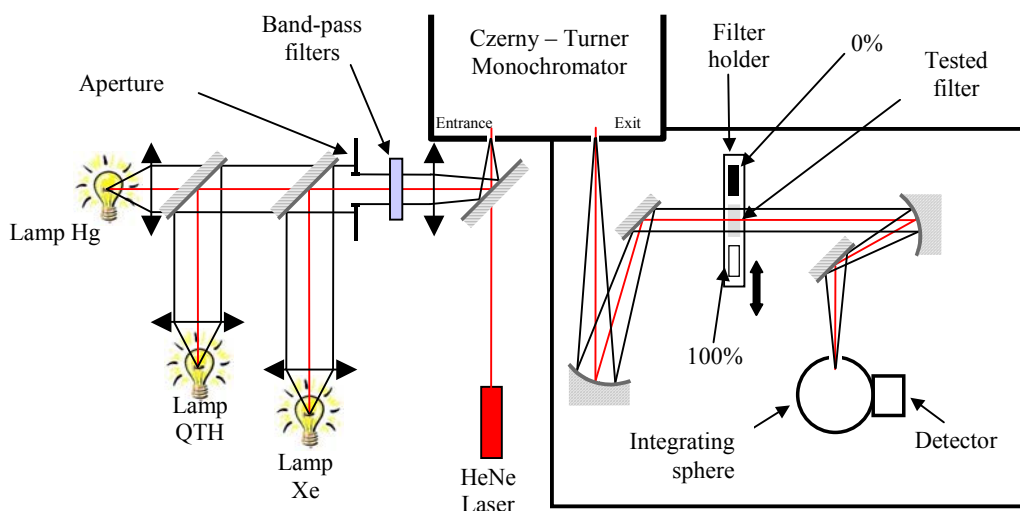

Figure 1 – Schematic drawing of the reference spectrometer.

Typical uncertainties

The uncertainties are absolute uncertainties

Table 4 : Type A uncertainties

λ (nm)	Filter "A"	Filter "B"	Filter "C"	Filter "D"	Filter "E"
380	6,16E-05	4,11E-04	1,52E-04	1,04E-05	6,54E-07
400	6,15E-05	6,61E-05	2,96E-05	4,13E-06	1,60E-06
500	6,15E-05	6,60E-05	2,92E-05	6,28E-06	1,67E-06
600	6,15E-05	6,68E-05	4,23E-05	9,88E-06	2,41E-06
700	6,15E-05	7,02E-05	3,48E-05	1,73E-05	4,01E-06
800	6,84E-05	1,22E-04	1,15E-04	2,21E-05	9,52E-06
900	6,83E-05	1,21E-04	8,09E-05	2,28E-05	8,33E-06
1000	6,83E-05	8,72E-05	6,24E-05	1,71E-05	7,05E-06

Table 5 : Type B uncertainties

λ (nm)	Filter "A"	Filter "B"	Filter "C"	Filter "D"	Filter "E"
380	6,20E-05	4,12E-04	1,52E-04	1,10E-05	1,00E-06
400	6,20E-05	6,70E-05	3,00E-05	5,00E-06	2,00E-06
500	6,20E-05	6,70E-05	3,00E-05	7,00E-06	2,00E-06
600	6,20E-05	6,70E-05	4,30E-05	1,00E-05	3,00E-06
700	6,20E-05	7,10E-05	3,50E-05	1,80E-05	5,00E-06
800	6,90E-05	1,23E-04	1,15E-04	2,30E-05	1,00E-05
900	6,90E-05	1,22E-04	8,10E-05	2,30E-05	9,00E-06
1000	6,90E-05	8,80E-05	6,30E-05	1,80E-05	8,00E-06

3.4. Circulation of the filters

Before the circulation of the filters, the technical protocol was circulated among the participants in February 2001. The technical procedure used in this protocol was identical to that used for the CCPR-K6 comparison; only the organisational part has been changed (Annex A). The allocation of filter sets to each laboratory was done at random and is summarized in Table 6.

Table 6 – Identification of the set of filters sent to the laboratories.

Laboratory acronym	Filter set identification
BEV	Set 22
CMI	Set 24
GUM	Set 26
IFA	Set 05
INM	Set 27
INRIM	Set 02
IPQ	Set 29
METAS	Set 21
MIKES	Set 16
VSL	Set 08
NPL	Set 04
MKEH	Set 30
PTB	Set 03
SMU	Set 11
SP	Set 28
UME	Set 13
VSL	Set 08

The filters were sent to the new participating laboratories in May 2001. The laboratories completed the measurements and sent back the filters before the end of the year 2001.

3.5. Measurements after return of the filters

The measurements after return of the filters started at the end of March 2002 and were completed at the beginning of July 2002. In order to check the stability of the filters, they were carried out exactly in the same way as the measurements before dispatching and without any cleaning.

3.6. Stability of the filters

The stability of the filters during the comparison was checked by calculating the absolute deviation of the transmittance of the filter according to the equation :

$$\text{Deviation} = \text{transmittance after} - \text{transmittance before} \quad (1)$$

The uncertainties taken into account for this study are only the uncertainties determined by type A methods of the measurements carried out by LNE-INM. Because measurements have been done in exactly the same conditions in both cases, most of the uncertainties determined by type B methods cancelled out or have a negligible effect. The results for the filters used in the comparison are given in Figure 2 to Figure 6.

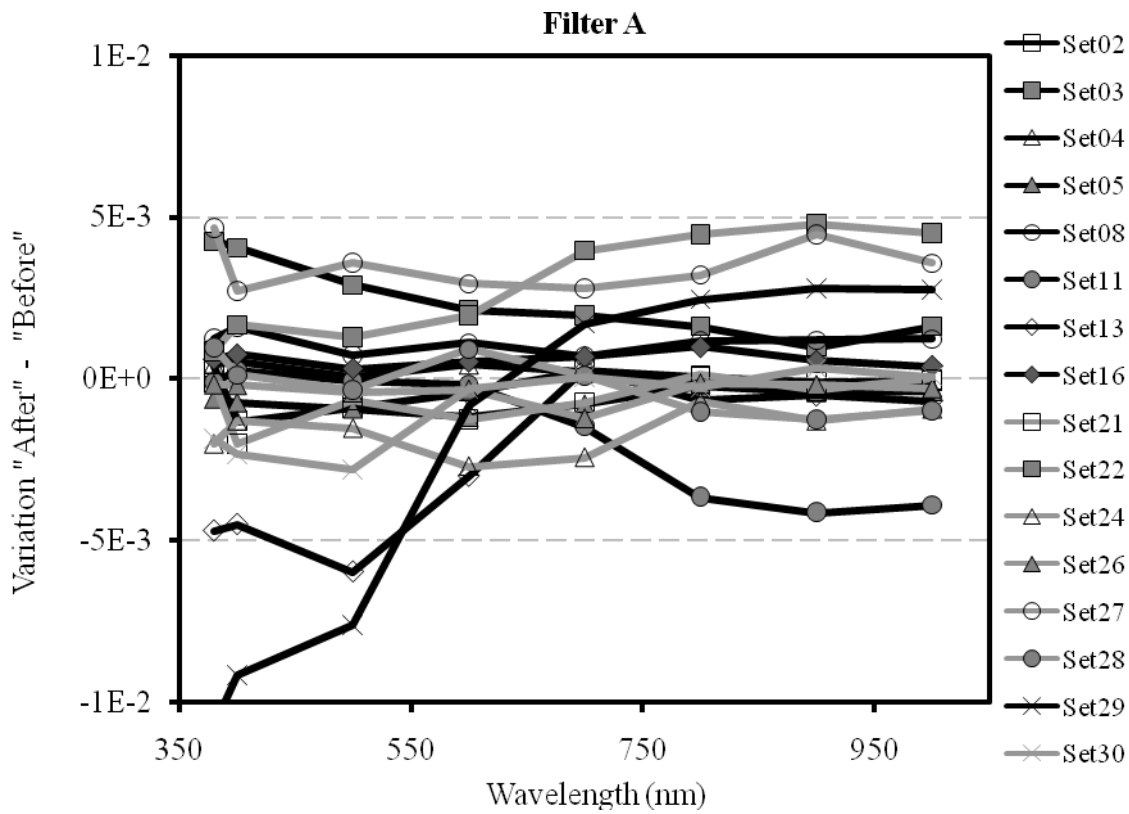

Figure 2 – Stability of type A filters during the comparison

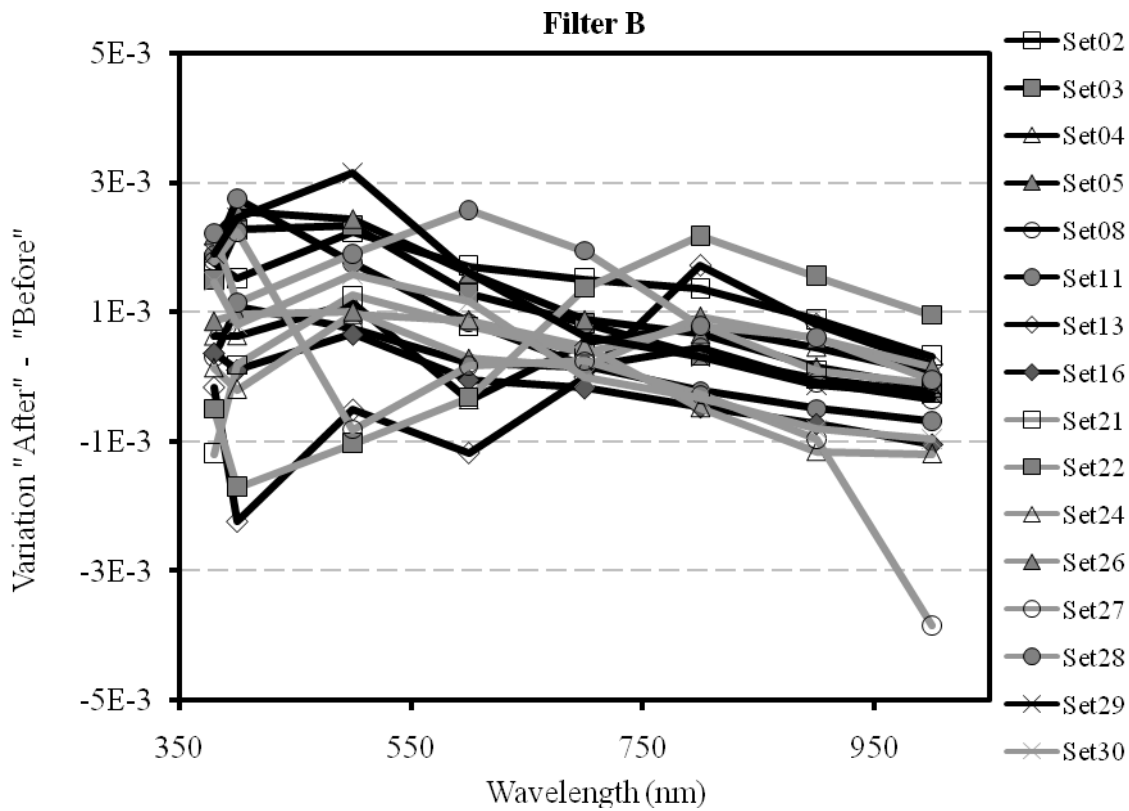

Figure 3 – Stability of type B filters during the comparison

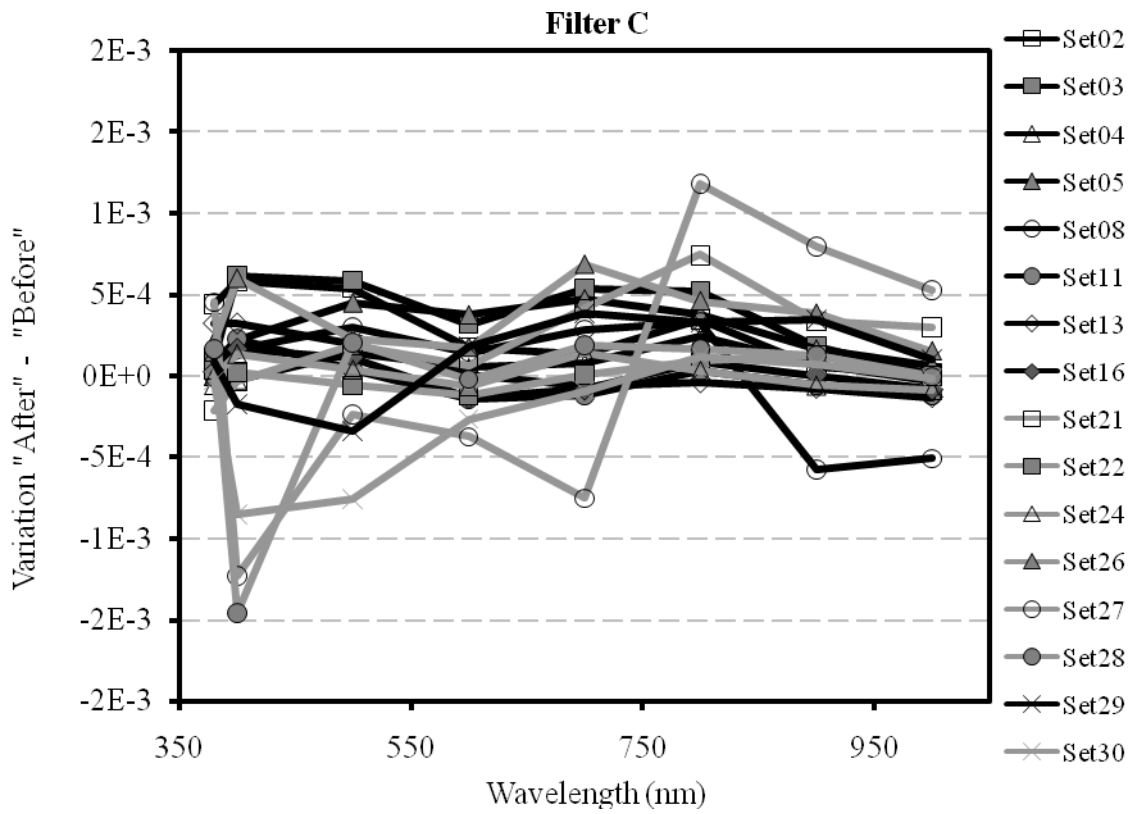

Figure 4 – Stability of type C filters during the comparison

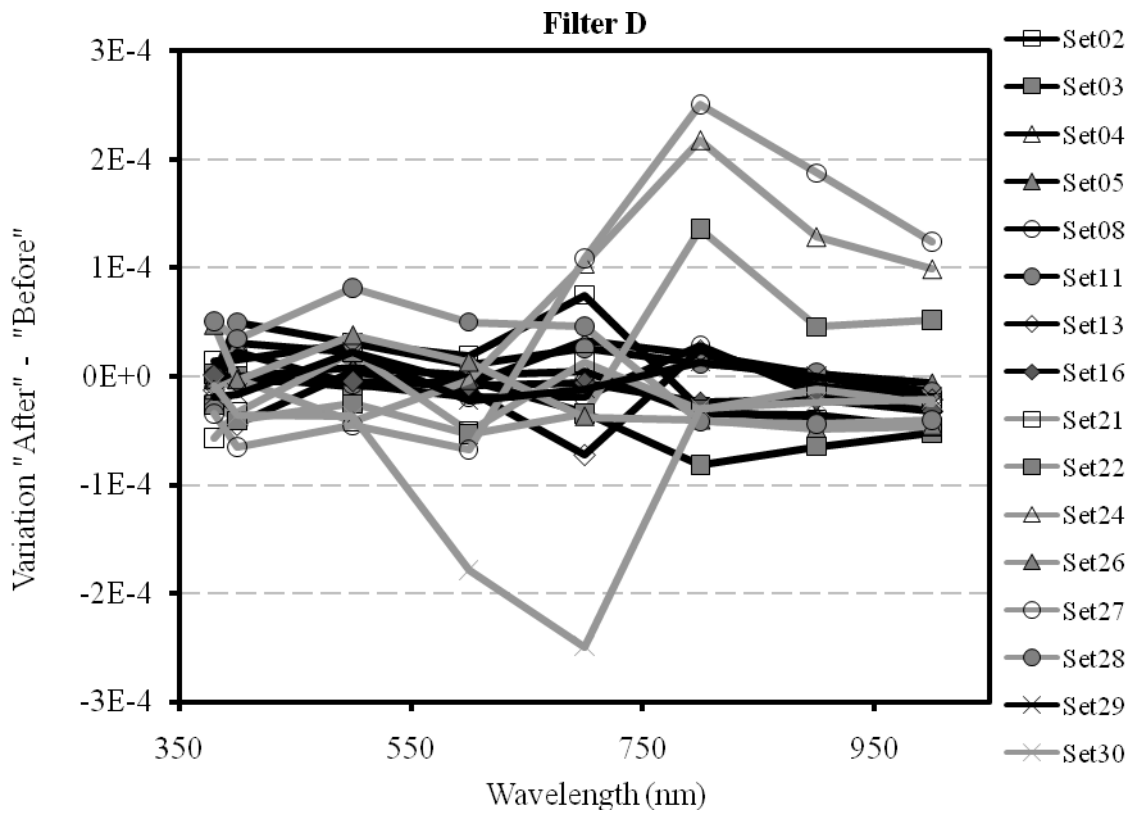

Figure 5 – Stability of type D filters during the comparison

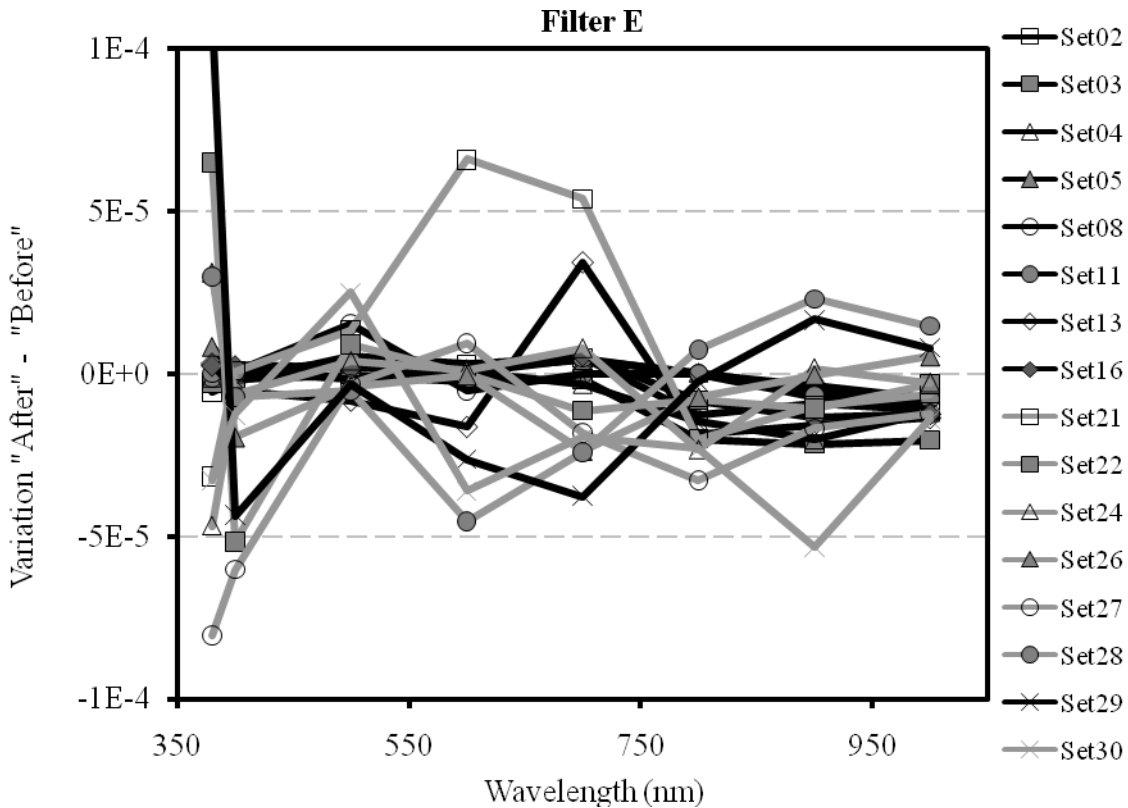

Figure 6 - Stability of type E filters during the comparison

As can be seen from the preceding graphs, the stability of the filters was rather poor. Moreover, the drift was wavelength dependent. As a consequence for many results, the uncertainty due to the drift of the filters during the comparison is the major cause of uncertainty, much larger than the measurement uncertainty of the measurements reported by the laboratories. A few filters, which exhibited a very small drift, give results with an uncertainty much smaller than the uncertainty value for the majority of the filters leading to difficulties in the data processing.

3.7. LNE - INM transmittance value

The transmittance value adopted by the LNE-INM for the filter was the mean value of measurements before and after the circulation of the filters.

4. Facilities, measurement methods and conditions, and uncertainties from the participating laboratories

Each participating laboratory has returned its transmittance measurements with a brief description of the experimental set up and a detailed uncertainties budget. These documents have been compiled together in two files, a "tables of facilities" and a "table of uncertainties". The files have been sent to all the participants for verification and validation. In the following, a résumé of this information is reported.

For each participating laboratory, we report:

- The make and type of the spectrophotometer

- The description of the measuring technique

- The description of calibration laboratory conditions

- If applicable, comments on filters.

- The "Type A" and "Type B" uncertainties for each filter and each wavelength.

4.1. BEV

Assigned set : #22

Make and Type of the spectrophotometer :

The measurements have been done in a purpose built spectrophotometer. This spectrophotometer features a single beam, prism double monochromator with 2 interchangeable sets of prisms one in flint glass for visible and another one in quartz for UV. The measurements reported here are all made with the flint glass prisms, although for consistency checking, also the quartz prisms have been used. The slit widths were adjusted to have a 1 nm band pass in the green spectral region.

The light source in this experiment was a 12 V/100 W tungsten halogen lamp in a lamp housing with a lens condenser. Two kinds of detectors were used : in most cases a 3-element silicon trap detector (reflection type) was employed. For the very dense filters and in the blue spectral region a PMT with S-20 characteristic was used.

Description of the measuring technique

The output slit is focused by a single biconvex spectroil lens on the respective detector surface. The field of irradiation on the filter was adjusted by means of an iris diaphragm to be a circle of diameter $20 \text{ mm} \pm 1 \text{ mm}$. This way the filters are placed in a slightly convergent light field with a F/# of 13.8 (half angle 2.1°).

For each wavelength the sequence of photocurrents for the following schema are determined:

$$D (R 1 2 3 4 R 4 3 2 1 D)^n$$

where D denotes dark value, R the reference condition (no filter) and 1, 2, 3, 4 the respective filters. The number of repetitions (n) is normally 10. This time-symmetric sequence minimizes drift effects. The transmittance is calculated after each of the n steps and the mean value together with the standard deviation is stored in a computer file for each wavelength.

Description of calibration laboratory conditions

The laboratory is air conditioned to a nominal temperature of 24°C . The temperature in the housing for the measurements is somewhat higher (dissipation of the stepping motor). The humidity was between 15 % and 29 %.

Comments on filters

After fixing the filter in the wheel they were only cleaned by a dust-free gas jet (from a bottle). No contact-method was used for the cleaning with the exception of filter A22 : on one occasion the gas outlet was too near to the filter and a residue was found on its surface. This spot was treated with a lens cleaning paper afterwards.

Uncertainties

The uncertainties are absolute uncertainties.

Table 7 : Type A uncertainties

λ (nm)	Filter "A"	Filter "B"	Filter "C"	Filter "D"	Filter "E"
380	2,70E-04	1,70E-04	7,00E-05	1,00E-05	1,00E-05
400	1,20E-04	2,90E-04	5,00E-05	1,00E-05	1,00E-05
500	9,00E-05	2,80E-04	9,00E-05	1,00E-05	1,00E-05
600	1,60E-04	4,00E-05	2,00E-05	1,00E-05	1,00E-05
700	1,30E-04	6,00E-05	1,40E-04	4,00E-05	1,00E-05
800	1,20E-04	7,00E-05	3,00E-05	4,00E-05	1,00E-05
900	2,70E-04	1,00E-04	1,80E-04	6,00E-05	1,00E-05
1000	1,40E-04	4,00E-05	3,00E-05	3,00E-05	0.00001

Table 8 : Type B uncertainties

λ (nm)	Filter "A"	Filter "B"	Filter "C"	Filter "D"	Filter "E"
380	1,30E-03	4,50E-03	1,10E-03	8,40E-05	8,40E-05
400	1,20E-03	1,40E-03	1,00E-03	7,70E-05	7,70E-05
500	1,20E-03	1,00E-03	5,00E-04	7,00E-05	7,00E-05
600	1,40E-03	1,10E-03	1,20E-03	1,20E-03	1,20E-03
700	1,30E-03	1,00E-03	1,20E-03	1,10E-03	1,00E-03
800	1,30E-03	1,00E-03	1,10E-03	1,00E-03	1,00E-03
900	1,30E-03	1,10E-03	1,10E-03	1,00E-03	1,00E-03
1000	1,70E-03	1,60E-03	1,10E-03	9,00E-05	9,00E-05

4.2. CMI

Assigned set : #24

Make and Type of the spectrophotometer:

At the CMI laboratory the measurements were performed on the CMI reference spectrophotometer designed and constructed in-house (see fig.7).

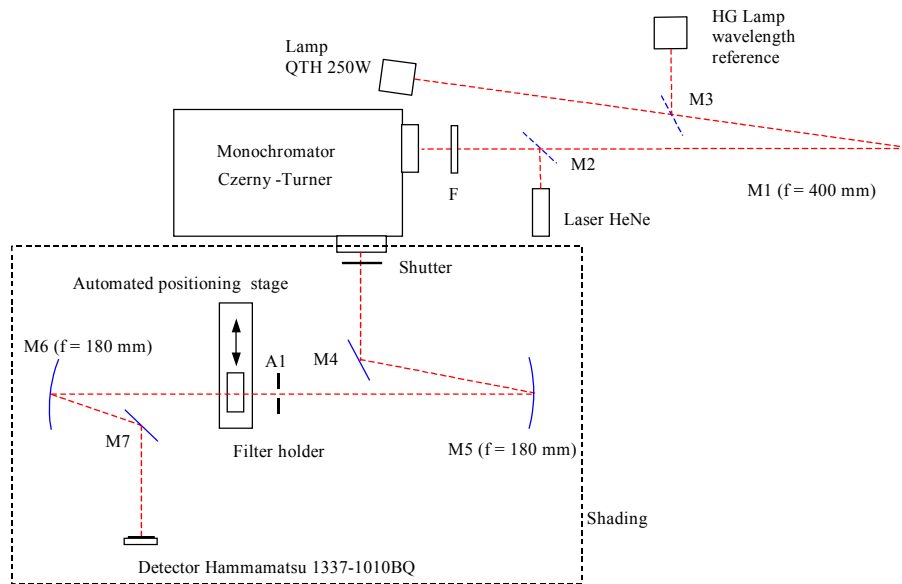

Figure 7: Schematic drawing of the CMI reference spectrophotometer. M1, M5, M6 – concave spherical mirrors; M2, M3 – moveable plane mirrors; M4, M7 – plane mirrors; F – filter for stray light suppression and order sorting; A – aperture 20 mm diameter; HeNe laser used for optical system and measured filter alignment.

A QTH lamp was used as the light source for the whole spectral range from 380 nm to 1000 nm. A Czerny-Turner monochromator (type McPherson 2035), with a grating ruled at 600 g/mm giving a bandpass of 2 nm at the exit slit of the monochromator, was used as the dispersion unit for the whole spectral range from 380 nm to 1000 nm. A Hamamatsu 1337-1010BQ silicon photodiode was used as the detector.

Description of the measuring technique

For the filter measurement, the parallel beam was applied (divergence smaller than 3 mrad), and the spot size on the filter was 20 mm diameter.

A He-Ne laser was applied both for the optical system alignment and for adjusting the filter position. The filter to be measured was placed on the adjustable holder on the automated linear translation stage. The measured filter position was adjusted both for normal incidence of the measuring beam (deviation smaller than 2 mrad, checked by laser beam) and for the measuring beam spot position (checked and reproduced within ± 1 mm).

For each filter and wavelength, 2 independent sets of 5 successive measurements were done. For each set of measurements, an independent realignment of the measuring system was performed.

Description of calibration laboratory conditions

The measurement was performed in the air conditioned laboratory. The temperature in the measurement area was within the interval (23 ± 1) °C during both sets of measurements and was measured for every single measurement with an uncertainty of 0.1 °C and reported. The relative humidity of air was within the interval (40 ± 10) % and was measured and reported as well.

Comments on filters

No cleaning of the filters has been done.

Uncertainties

The uncertainties are absolute uncertainties

Table 9 : Type A uncertainties

λ (nm)	Filter "A"	Filter "B"	Filter "C"	Filter "D"	Filter "E"
380	1,20E-04	5,00E-05	4,00E-05	1,10E-05	4,00E-06
400	1,30E-04	9,00E-05	3,00E-05	2,20E-05	2,90E-05
500	1,40E-04	1,00E-04	1,00E-05	3,00E-06	1,10E-05
600	9,00E-05	7,00E-05	1,00E-05	4,00E-06	1,30E-05
700	1,50E-04	9,00E-05	2,00E-05	3,00E-06	7,00E-06
800	8,00E-05	7,00E-05	1,00E-05	5,00E-06	6,00E-06
900	9,00E-05	5,00E-05	1,00E-05	5,00E-06	4,00E-06
1000	9,00E-05	5,00E-05	1,00E-05	2,00E-06	2,00E-06

Table 10 : Type B uncertainties

λ (nm)	Filter "A"	Filter "B"	Filter "C"	Filter "D"	Filter "E"
380	3,58E-04	2,58E-04	6,71E-05	6,52E-05	6,08E-05
400	3,58E-04	2,58E-04	6,71E-05	6,52E-05	6,08E-05
500	3,58E-04	2,58E-04	6,71E-05	6,52E-05	6,08E-05
600	3,58E-04	2,58E-04	6,71E-05	6,52E-05	6,08E-05
700	3,58E-04	2,58E-04	6,71E-05	6,52E-05	6,08E-05
800	3,58E-04	2,58E-04	6,71E-05	6,52E-05	6,08E-05
900	3,58E-04	2,58E-04	6,71E-05	6,52E-05	6,08E-05
1000	3,58E-04	2,58E-04	6,71E-05	6,52E-05	6,08E-05

Remark on results: After circulation of the Draft A1, CMI checked its data for filter C24 at 500 nm, filter D24 at 500 nm and filter E24 at 1000 nm, which seemed to them to be outliers from the mean value. They traced back their results and found that it appeared to be a calculation error, in particular in the way of averaging all sets of data. They proposed corrected values and

these are given below only for information. In accordance with the key comparison guidelines, they have not been taken into account in the final results of the key comparison.

Filter	Wavelength (nm)	Transmittance	Uncertainty (Type A and B, $k=1$)
C24	500	0.09065	0.00006
D24	500	0.008389	0.00001
E24	1000	0.006869	0.00001

4.3. GUM

Assigned set : #26

Make and Type of the spectrophotometer:

The reference spectrophotometer at the GUM is a Cary 5 UV-Vis-NIR spectrophotometer manufactured by Varian. It is a double beam spectrophotometer with double out-of-plane Littrow monochromators and dual double-sided gratings. The spectrophotometer is centrally controlled by a PC. The UV-Vis detector is a high performance R928 photomultiplier, and the NIR detector is a thermoelectrically-controlled lead sulphide photocell. Light sources are a deuterium lamp and quartz-halogen lamp.

The spectrophotometer characteristics were checked one month before the comparison with the use of special filters in the context of a manufacturer maintenance service. We also carried out measurements of spectral transmittance and spectral transmittance optical density of three filters (set number 2253) which were measured and certified by NIST. The comparison of our results with the certified values showed good agreement of the results.

Description of the measuring technique

Before measurements, all filters were mounted in metal holders and then put in position with engraved references facing the incident beam. The beam was horizontally imaged in the centre of the filter compartment.

Some beam details :

- polarization identical in reference and sample beams,
- size of beam imaged on the sample: 13.35 mm vertically and 5.1 mm horizontally,
- beams only partially polarized,
- maximum vertical angle of incidence of sample : 7.61° ,
- maximum horizontal angle of incidence of sample : 3.22° .

The filter transmittance at a given wavelength was measured ten times, in repeatability and reproducibility conditions. The reported values of standard deviation are values of experimental standard deviation of the mean. The U_1 uncertainty component is the square root of the sum of experimental standard deviations of the mean in repeatability and reproducibility conditions (both values are similar). The reported data reflects only repeatability component (measured and calculated according to clause 4.2.1 of the Technical Protocol). Reproducibility component has been also measured and calculated (4.2.2) but its share was combined with repeatability (square root of sum of quadratic components) and given as min-max values in table in A.3 (in the Technical Protocol) as a repeatability. Components of uncertainty resulting from nonlinearity of the detector, wavelength setting of the monochromator and the stray light were determined from the specifications of the spectrophotometer, additional tests and calculations. The uncertainty caused by stray light is negligible. Components of uncertainty resulting from beam displacement, uniformity of the sample and obliquity effect are evaluated on the basis of the manufacturing tolerances of filters and our laboratory practice.

Description of calibration laboratory conditions

There was no air conditioning in the calibration room. The ambient temperature was measured in the filter compartment. Values of temperature were in the range (23.6 to 24.6) °C.

Comments on filters

The filters were not cleaned; only dust was removed with a special air spray.

Uncertainties

The uncertainties are absolute uncertainties

Table 11 : Type A uncertainties

λ (nm)	Filter "A"	Filter "B"	Filter "C"	Filter "D"	Filter "E"
380	2,10E-05	1,70E-05	4,00E-06	3,00E-07	3,00E-07
400	1,50E-05	1,90E-05	6,00E-06	9,00E-07	3,00E-07
500	2,10E-05	1,20E-05	4,00E-06	8,00E-07	4,00E-07
600	1,70E-05	1,80E-05	7,00E-06	1,00E-06	4,00E-07
700	2,80E-05	1,50E-05	1,10E-05	3,00E-06	7,00E-07
800	4,90E-05	2,20E-05	1,20E-05	5,00E-06	3,00E-06
900	1,60E-05	2,70E-05	3,00E-06	1,00E-06	1,00E-06
1000	1,20E-05	1,30E-05	2,00E-06	2,00E-06	1,00E-06

Table 12 : Type B uncertainties

λ (nm)	Filter "A"	Filter "B"	Filter "C"	Filter "D"	Filter "E"
380	2,82E-04	1,90E-04	1,44E-04	5,19E-05	2,09E-05
400	2,82E-04	1,90E-04	1,44E-04	5,19E-05	2,09E-05
500	2,82E-04	1,90E-04	1,44E-04	5,19E-05	2,09E-05
600	2,82E-04	1,90E-04	1,44E-04	5,19E-05	2,09E-05
700	2,82E-04	1,90E-04	1,44E-04	5,19E-05	2,09E-05
800	2,82E-04	1,90E-04	1,44E-04	5,19E-05	2,09E-05
900	2,82E-04	1,90E-04	1,44E-04	5,19E-05	2,09E-05
1000	2,82E-04	1,90E-04	1,44E-04	5,19E-05	2,09E-05

4.4. IFA

Assigned set : #5

Make and Type of the spectrophotometer:

The measurements have been done in a purpose-built spectrophotometer. This spectrophotometer features a single beam, single monochromator with 3 interchangeable diffraction gratings. Although this is a single-grating monochromator, stray light is lower than 100 ppm. of the detector signal. A 1200 g/mm grating has been used for the calibration in the UV/Visible spectral range (380, 400, 500, 600, 700 and 800) nm wavelengths, while a 600 g/mm grating has been used for the calibration in the near-IR spectral interval (900 nm and 1000 nm). Long wave pass filters have been used in both intervals to eliminate second-order wavelength radiation. Filter and grating changes are automatic during monochromator slewing.

A tungsten lamp and one silicon detector have been used for the whole spectral range.

Description of the measuring technique

Samples were illuminated by a parallel beam impinging normally. The spot size was 23 mm diameter. Measurements have been done at a nominal bandwidth of 3.4 nm in the UV/VIS range for the filters identified as A05, B05 and C05; and 5 nm for the filters D05 and E05. In the near IR (900 and 1000 nm wavelengths), the measurements have been done at a nominal bandwidth of 3 nm for all the filters.

The spectral transmittance of the filters has been determined by comparing the detector response with and without the filter in the beam. The calibration procedure consists of recording, at each wavelength, the detector response to the calibration beam without filter and with the filter inserted in the beam. The spectral transmittance is determined then, as the ratio of these detector responses. A second detector is used to monitor the power temporal drift of the calibration beam. Each filter has been measured in four different positions. Every position was obtained by rotating the filter by 90° about the optical axis. This procedure has been repeated three times, resulting in 12 independent measurements for each filter.

Description of calibration laboratory conditions

Filter temperature is assumed to be that of the calibration enclosure. This temperature was always between 23°C and 25°C.

Comments on filters

No cleaning of the filters has been done

Uncertainties

The uncertainties are absolute uncertainties

Table 13 : Type A uncertainties

λ (nm)	Filter "A"	Filter "B"	Filter "C"	Filter "D"	Filter "E"
380	5,40E-04	2,70E-04	1,10E-04	1,30E-05	1,60E-05
400	6,20E-05	3,10E-04	9,10E-05	1,40E-05	1,20E-05
500	4,00E-05	2,20E-04	5,50E-05	6,90E-06	5,40E-06
600	9,50E-05	2,70E-04	1,10E-05	4,60E-06	2,80E-06
700	7,20E-05	2,20E-04	1,80E-05	3,70E-06	3,60E-06
800	2,40E-05	1,70E-04	1,90E-05	9,00E-06	9,90E-06
900	6,70E-05	1,20E-04	1,60E-05	1,50E-06	1,20E-06
1000	4,10E-05	2,40E-04	2,20E-05	1,50E-06	1,90E-06

Table 14 : Type B uncertainties

λ (nm)	Filter "A"	Filter "B"	Filter "C"	Filter "D"	Filter "E"
380	2,34E-03	7,53E-04	8,66E-05	1,52E-05	4,74E-05
400	2,80E-03	1,57E-03	2,11E-04	2,65E-05	3,82E-05
500	4,98E-04	3,34E-04	2,14E-05	6,67E-06	8,42E-06
600	6,94E-04	4,21E-04	6,20E-05	7,38E-06	5,31E-06
700	2,30E-03	1,38E-03	3,19E-04	4,99E-05	9,33E-06
800	6,00E-04	3,62E-04	9,61E-05	2,33E-05	1,41E-06
900	2,10E-03	9,93E-04	1,99E-04	2,40E-05	9,93E-06
1000	2,00E-03	1,28E-03	8,11E-05	2,09E-05	1,18E-05

4.5. INM

Assigned set : #27

Make and Type of the spectrophotometer:

The INM reference instrument is the SFTA 1 absolute spectrophotometer (Fig. 8), a dedicated instrument of INM make. It provides absolute transmittance calibrations according to the ISO 31/6 definition of optical transmittance.

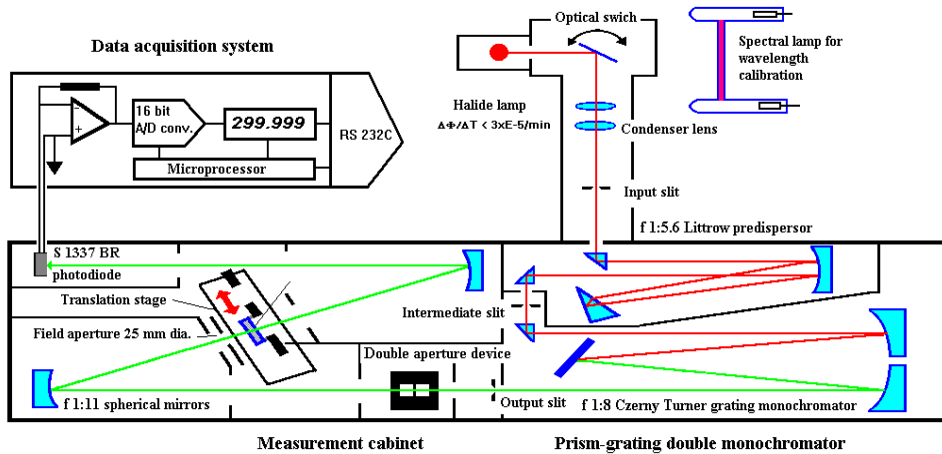

Figure 8 - SFTA 1 - the primary standard of the BRML-INM

SFTA 1 is a single-channel, dc-mode operated instrument provided with a permanently installed double-aperture device to be used for non linearity correction of the detector signal.

SFTA 1 main features / characteristics are :

Transmittance range : 0.01 to 1.00000

Usable wavelength range : 300 nm to 1000 nm

Current measurement half bandwidth : fixed, at 1.5 nm

Beam geometry : circular, collimated, of 25 mm dia., near-normal to the sample (incidence is at 0.7 °).

The transmittance scale is characterized according to the signal addition method, using the double aperture device. The nonlinearity correction factor C_{lin} was estimated according to the signal addition method, using the double aperture device. Two rectangular apertures of equal areas were used to provide either separate signals $Y(A)$ and $Y(B)$ or the combined signal $Y(A+B)$.

The two apertures position was finely adjusted such as to provide photometric signals $Y(A)$ and $Y(B)$ equal within 1 %. The correction factor was computed with the formula:

$$C_{lin,i} = \frac{Y_i(A) + Y_i(B)}{Y_i(A+B)}$$

$C_{lin,i}$ was experimentally estimated by cascade measurements at different values of $Y_i(A+B)$, covering the $(1/32 \dots 1/1) Y_{max}$ range. For every measurement, the dark signal $Y(0)$ was subtracted and for each step i , the measurements were repeatedly performed in a time symmetrical sequence:

$Y_i(0) - Y_i(A) - Y_i(B) - Y_i(A+B) - Y_i(B) - Y_i(A) - Y_i(0)$ To achieve the required signal ratios, the full signal level $Y_i(A+B)$ was adjusted either by lamp current supply adjustment and by inserting

neutral filters of different transmittance between the monochromator exit slit and the double aperture device.

The mean nonlinearity correction factor was found to be of 0.99997 with an estimated standard uncertainty of 0.00003. It was further applied to the mean indications acc:

$$T_{corr} = C_{lin} \cdot T_{ind}^n \quad \text{where } n \text{ is implicitly defined by: } T_{corr} = (1/2)^n$$

The wavelength accuracy was characterized by using spectral lamps with Hg, He and Ne. They may be very easily switched on the measurement beam with the optical switch permanently installed on the radiation source frame (Fig. 1). According to this technique, the effective wavelength accuracy is characterized by a standard uncertainty of 0.2 nm. The spectral lamps were also employed to estimate the half bandwidth of the instrument (1.5+/-0.3 nm).

The heterochromatic stray light is mostly reduced by the double monochromator (Fig. 1). Repeated tests with cut off filters brought us to the conclusion that this component is well below 0.01% of the useful flux. The monochromatic stray light diffused in the sample compartment was estimated to be < 0.0001 of the useful flux and an estimated uncertainty of 0.00005 (0.005% of the useful flux) was associated.

Description of the measuring technique

All the measurements were performed with the marked surface of the filters oriented toward the monochromator exit slit. For the A27, B27 and C27 filters at least the measurement technique is very straightforward. The three filters were calibrated by direct comparison with the transmittance scale represented on/with the SFTA 1. The D27 filter was first calibrated relative to the C27 filter and then, its absolute transmittance was obtained by computation. The filter E27 was calibrated in the same manner against the D27 filter. However, at 380 nm, the E27 filter spectral transmittance was so low (<0.0002) that it was practically impossible to reasonably measure its transmittance value with our instrument. In the D27 and E27 calibration case, the estimated uncertainties were significantly larger since the C27 and D27 filters calibration uncertainty had to be considered also.

In all situations, whether absolute or relative calibrations are performed, in order to minimize the system drift influence, the basic measurement sequence is a time symmetrical one as indicated below :

"Zero", "Sample", "Ref.", "Sample", "Ref.", "Sample", "Ref.", "Sample", "Zero"

The "Zero" signal is read when the filter is replaced by a completely opaque polished glass with an approximate refractive index of 1.56. The "Ref" signal is read when the optical path is free (air). Each individual reading is performed on a dc voltmeter having an integration time of about 3 sec. Mean values are computed for the "Zero", "Sample" and "Reference" signal and the individual sample transmittance value, τ_i , is calculated according to :

$$\tau_i = (\text{mean "Sample"} - \text{mean "Zero"}) / (\text{mean "Ref."} - \text{mean "Zero"})$$

Five such values are used to compute the uncorrected mean value for the given filter at the given wavelength. Further corrections for beam geometry, effective wavelength and spectral bandwidth, stray light, photometric non-linearity, filter non-uniformity, etc. were theoretically and/or experimentally estimated and applied.

Description of calibration laboratory conditions

Temperature: (23 \pm 0.5) °C
Humidity: (50 \pm 10) %

Comments on filters

The A27 filter was cleaned with 10% ethyl alcohol in deionised water and using hydrophilic cotton, with very gentle pressure.

An increase in the value of the transmittance was noticed during the laboratory measurements for filters A27, B27 and C27. It led us to think that maybe the air-glass interfaces of the #27 set filters were not yet completely stabilized.

Uncertainties

The uncertainties are absolute uncertainties

Table 15 : Type A uncertainties

λ (nm)	Filter "A"	Filter "B"	Filter "C"	Filter "D"	Filter "E"
380	1,37E-04	5,94E-04	2,51E-05	6,25E-07	
400	1,01E-04	1,76E-04	7,84E-05	3,55E-06	3,57E-07
500	9,27E-05	1,81E-04	4,13E-05	4,34E-06	2,98E-07
600	1,29E-04	1,77E-04	5,64E-05	5,38E-06	1,06E-07
700	1,38E-04	1,72E-04	5,85E-05	1,71E-05	2,12E-06
800	1,38E-04	6,37E-05	6,76E-05	1,60E-05	4,02E-06
900	1,93E-04	5,03E-05	6,28E-05	8,03E-06	3,50E-06
1000	10,12E-04	6,44E-04	1,49E-04	1,43E-05	1,31E-05

Table 16 : Type B uncertainties

λ (nm)	Filter "A"	Filter "B"	Filter "C"	Filter "D"	Filter "E"
380	7,60E-04	2,99E-03	5,34E-04	1,14E-05	
400	6,08E-04	3,27E-04	2,22E-04	2,44E-05	1,78E-06
500	5,44E-04	2,67E-04	1,18E-04	1,32E-05	1,76E-06
600	5,45E-04	2,62E-04	1,27E-04	1,71E-05	2,37E-06
700	5,46E-04	2,75E-04	2,84E-04	5,27E-05	1,16E-05
800	5,46E-04	2,56E-04	1,28E-04	3,31E-05	1,24E-05
900	5,46E-04	2,39E-04	1,14E-04	2,85E-05	1,24E-05
1000	5,52E-04	3,03E-04	1,21E-04	3,68E-05	1,79E-05

4.6. INRIM

Assigned set : #2

Make and Type of the spectrophotometer :

The Perkin Elmer Lambda 900 spectrometer is a commercial device with double beam and double monochromator. The INRIM instrument has a common beam depolarizer (model B0501282).

The main sources of uncertainty were evaluated or checked as follows.

Linearity check has been partially performed using a technique currently under verification.

The beam divergence and beam dimensions have been measured using a CCD detector at different positions of the optical path. At the incidence sample surface, the measured values are approximately for the beam divergence 3° and for the beam size 6×3 mm rectangular.

The influence of polarization has been checked using measurements carried out with and without the depolarizer. The results of the comparison refer to measurements with the depolarizer in the optical path. Measurements carried out with the same instrument and similar samples with or without the depolarizer show differences in absolute values between $4 \cdot 10^{-4}$ to $5 \cdot 10^{-6}$.

Inter-reflections have been evaluated by repeating measurements both with another filter in the optical path or turning the filter by 3° .

The short-term drift has been evaluated by comparing, wavelength by wavelength, the results of the first measurement in a trial and of the last one. The long-term drift was evaluated with preliminary measurements carried out continuously for 2 h after an instrument calibration.

The catalogue specification of stray light at 370 nm is less than 0,00008 %T

The catalogue specification of wavelength uncertainty is 0,8 nm.

Unfortunately, because the instrument's performance and capabilities are not yet fully tested, it is not possible to provide results at 380 nm of sample D and at 380 and 400 nm of sample E.

Description of the measuring technique

Each sample has been characterised through 6 or 7 repetitions of a measurement trial. The following steps comprised each trial :

zero signal baseline evaluation;

100% signal baseline evaluation;

sample transmittance measurements (performed 3 times for each sample)

Between trials, the samples were removed and realigned on the same sample holder and, for a given sample, the instrument was switched off and on on another day.

The experimental standard uncertainty of the mean was evaluated using the ANOVA algorithm to verify if the between-trial variability is significant in comparison with the within-trial variability.

To obtain more statistical information and to verify the instrument performance during all the measurement days, the trials were grouped in sets of trials. All the measurements in a set of trials were carried out in the same day. In a set, the trial was organized as follows : 0 %, 100 %, A, B, C, D, E, 100 %, 0 %.

Description of calibration laboratory conditions

Filter temperature is assumed to be that of the calibration enclosure : $(23 \pm 3)^\circ\text{C}$

Humidity : $(55 \pm 10) \%$

Comments on filters

The dust on the surface was removed using only air and a soft brush.

Uncertainties

The uncertainties are absolute uncertainties

Table 17 : Type A uncertainties

λ (nm)	Filter "A"	Filter "B"	Filter "C"	Filter "D"	Filter "E"
380	4,15E-05	1,54E-04	1,17E-05	-	-
400	4,01E-05	6,35E-05	2,18E-05	1,94E-06	-
500	3,86E-05	5,03E-05	7,68E-06	1,22E-06	7,85E-07
600	4,13E-05	5,05E-05	5,84E-05	2,83E-06	6,43E-07
700	3,86E-05	5,50E-05	9,32E-06	3,86E-06	1,18E-06
800	3,68E-05	5,50E-05	6,31E-06	1,89E-06	5,96E-07
900	6,66E-05	4,34E-05	1,33E-05	1,05E-05	7,21E-06
1000	5,64E-05	4,74E-05	7,76E-06	9,34E-06	5,68E-06

Table 18 : Type B uncertainties

λ (nm)	Filter "A"	Filter "B"	Filter "C"	Filter "D"	Filter "E"
380	5,43E-04	2,47E-03	7,46E-04	-	-
400	5,26E-04	7,97E-04	4,77E-04	6,30E-05	-
500	5,15E-04	3,85E-04	1,34E-04	1,00E-05	5,38E-07
600	5,08E-04	3,77E-04	7,66E-05	1,92E-05	9,50E-07
700	5,13E-04	4,00E-04	4,52E-04	7,19E-05	9,24E-06
800	5,10E-04	5,50E-04	2,11E-04	3,82E-05	4,73E-06
900	5,28E-04	5,38E-04	1,97E-04	4,97E-05	4,51E-06
1000	5,22E-04	3,82E-04	7,87E-05	1,42E-05	3,61E-06

4.7. IPQ

Assigned set : #29

Make and Type of the spectrophotometer:

The measurements have been done with a commercial spectrophotometer Varian Cary 500. It has a double monochromator with selectable spectral bandwidth. Full specifications of this equipment can be found at the address : <http://www.varianinc.com/osi/uv/brochure/87-1873.pdf>.

Description of the measuring technique

The calibration procedures for the various characteristics of the instrument have been carried out using calibrated and intrinsic standards. The geometric conditions for the measurements were : 0° incidence / 0° observation. The 100% baseline was adjusted on air for the reference and sample beams. Five measurements have been carried out in each of the three cycles performed on different occasions.

Description of calibration laboratory conditions

The laboratory uses an air-conditioning system to accurately control the temperature. The temperature was set to 23 °C with a maximum deviation of +/- 1 °C. The humidity was about 43 %RH during the measurements.

Comments on filters

No comments.

Uncertainties

The uncertainties are absolute uncertainties

Table 19 : Type A uncertainties

λ (nm)	Filter "A"	Filter "B"	Filter "C"	Filter "D"	Filter "E"
380	3,70E-03	3,59E-03	4,60E-05	1,00E-05	1,00E-05
400	3,24E-03	2,60E-04	8,80E-05	1,90E-05	7,00E-06
500	2,29E-03	4,70E-04	5,10E-05	1,10E-05	6,00E-06
600	1,81E-03	2,90E-04	8,60E-05	1,50E-05	1,10E-05
700	1,22E-03	3,20E-04	1,23E-04	1,70E-05	1,40E-05
800	6,30E-04	4,20E-04	2,29E-04	4,90E-05	3,10E-05
900	9,90E-04	3,10E-04	6,60E-05	8,50E-05	6,60E-05
1000	9,10E-04	4,30E-04	6,50E-05	7,30E-05	8,70E-05

Table 20 : Type B uncertainties

λ (nm)	Filter "A"	Filter "B"	Filter "C"	Filter "D"	Filter "E"
380	7,55E-05	7,55E-05	7,55E-05	7,55E-05	7,55E-05
400	7,55E-05	7,55E-05	7,55E-05	7,55E-05	7,55E-05
500	7,55E-05	7,55E-05	7,55E-05	7,55E-05	7,55E-05
600	7,55E-05	7,55E-05	7,55E-05	7,55E-05	7,55E-05
700	7,55E-05	7,55E-05	7,55E-05	7,55E-05	7,55E-05
800	7,55E-05	7,55E-05	7,55E-05	7,55E-05	7,55E-05
900	7,55E-05	7,55E-05	7,55E-05	7,55E-05	7,55E-05
1000	7,55E-05	7,55E-05	7,55E-05	7,55E-05	7,55E-05

4.8. METAS

Assigned set : #21

Make and Type of the spectrophotometer

Jobin-Yvon Monochromator Type HR640, with a set of high pass-filters at the entrance port in order to reduce the stray light from higher diffraction orders.

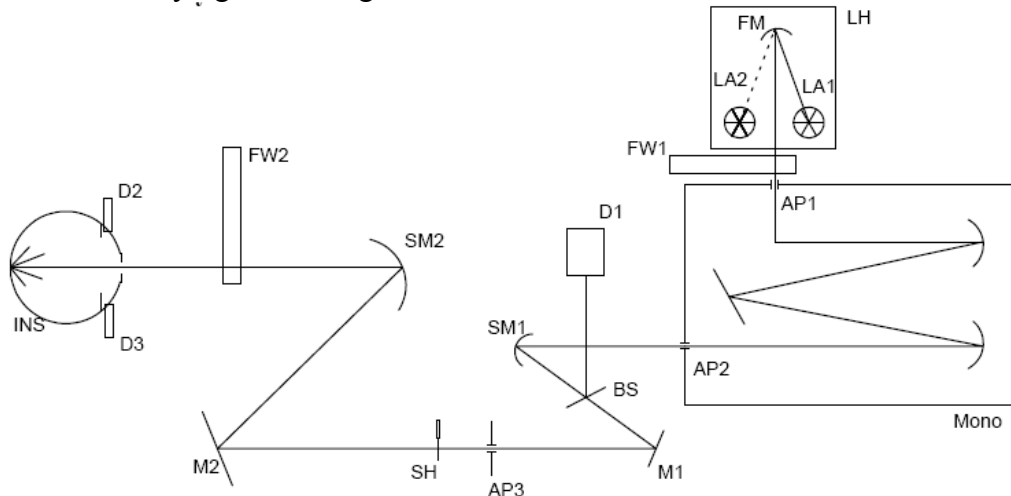

Figure 9 set up METAS

Legend

LH : lamp-house

LA1 : tungsten halogen lamp (6.6 A, 45W)

LA2 : Xenon high pressure

FM : flip-mirror

FW1 : filter-wheel including 5 bandpass filters, plus one clear aperture

AP1 : rectangular input aperture (10 mm x 2 mm)

Mono : grating monochromator $f=640\text{mm}$ ($f\#=5.6$)

AP2 : rectangular exit aperture (10 mm x 2 mm)

SM1, SM2 : spherical mirrors

BS : beam-splitter (quartz-plate)

M1, M2 : flat mirrors

FW2 : filter-wheel holding 4 filters under test and one clear aperture

INS : integrating sphere (50 mm diameter, 10 mm input aperture)

D1 : monitor detector (Si-trap)

D2 : UV enhanced Si photodiode

D3 : Photomultiplier

For wavelengths larger than 600 nm, a standard Si trap detector was used instead of the integrating sphere.

Description of the measuring technique

The monochromator illuminates the filter surface perpendicularly and with a slowly converging beam. At each wavelength, the flux is measured with and without the filter. and 10 of these measurement cycles were averaged. Furthermore, during the measurements, the stability of the source was monitored with an additional detector.

Description of calibration laboratory conditions

The temperature varied between 21 and 23 °C during all series of measurements, however less than 0.4°C during a measurement cycle.

Comments on filters

No cleaning has been done.

Uncertainties

The uncertainties are absolute uncertainties.

Table 21 : Type A uncertainties

λ (nm)	Filter "A"	Filter "B"	Filter "C"	Filter "D"	Filter "E"
380	2,70E-04	3,40E-04	1,00E-04	1,20E-06	4,60E-07
400	1,30E-04	1,00E-04	4,90E-05	8,00E-06	6,00E-07
500	2,40E-04	3,40E-04	7,20E-05	1,30E-05	1,30E-06
600	1,40E-04	1,00E-04	2,00E-05	7,00E-06	8,00E-07
700	1,50E-04	1,10E-04	1,20E-04	3,00E-06	3,60E-06
800	1,40E-04	9,00E-05	1,00E-04	2,50E-05	3,60E-06
900	2,80E-04	5,00E-05	1,00E-05	1,40E-05	6,40E-06
1000	5,50E-04	1,10E-04	3,80E-05	1,90E-05	1,13E-05

Table 22 : Type B uncertainties

λ (nm)	Filter "A"	Filter "B"	Filter "C"	Filter "D"	Filter "E"
380	2,23E-04	7,90E-04	1,50E-04	4,23E-06	1,37E-07
400	2,25E-04	1,62E-04	7,43E-05	1,02E-05	1,26E-06
500	1,96E-04	1,46E-04	3,71E-05	5,20E-06	9,33E-07
600	2,07E-04	1,37E-04	2,87E-05	8,49E-06	8,94E-07
700	2,00E-04	1,42E-04	9,00E-05	2,28E-05	7,26E-06
800	2,07E-04	1,44E-04	6,63E-05	2,00E-05	6,24E-06
900	2,10E-04	1,62E-04	5,92E-05	1,70E-05	5,59E-06
1000	2,14E-04	1,42E-04	4,11E-05	1,11E-05	5,34E-06

4.9. MIKES

Assigned set: #16

Make and Type of the spectrophotometer:

The spectrometer is an automated single-beam instrument with collimated normal-incidence beam geometry. The light source is a flat-filament 150-W quartz-tungsten-halogen lamp for the measurements at visible and NIR wavelengths and a 150-W xenon-arc light source for the UV and short-wavelength visible measurements.

The monochromator is a diffraction grating apparatus with three interchangeable gratings for the UV, visible, and NIR wavelength ranges. It is a Fasti asymmetrical circuit using spherical mirror objectives of 600-mm focal length. The gratings for the UV, visible, and NIR ranges are replicas with 1200, 1200, and 600 lines/mm, respectively, and with dimensions of 100 mm × 100 mm. The working ranges are from 200 nm to 500 nm, 350 nm to 1000 nm, and 700 nm to 2000 nm for the UV, visible, and NIR replicas, respectively.

The narrow bandwidth light beam emerging from the monochromator is collimated and directed towards the detector unit by a 90-degree off-axis parabolic mirror. The beam size is 20 mm × 22 mm at the vicinity of the parabolic mirror and its final shape is defined by an iris diaphragm.

The detector unit includes a 110-mm-diameter averaging sphere with an input-port diameter of 20 mm. An interchangeable detector is mounted to the output port of the averaging sphere. A silicon photodiode is used for measurements at visible wavelengths and an InGaAs photodiode is used for measurements at NIR wavelengths. The active area of the photodiodes is 100 mm² and each detector includes a low-noise transimpedance amplifier. For short visible wavelengths, the averaging sphere detector was replaced with a large-area silicon trap detector and a transimpedance amplifier.

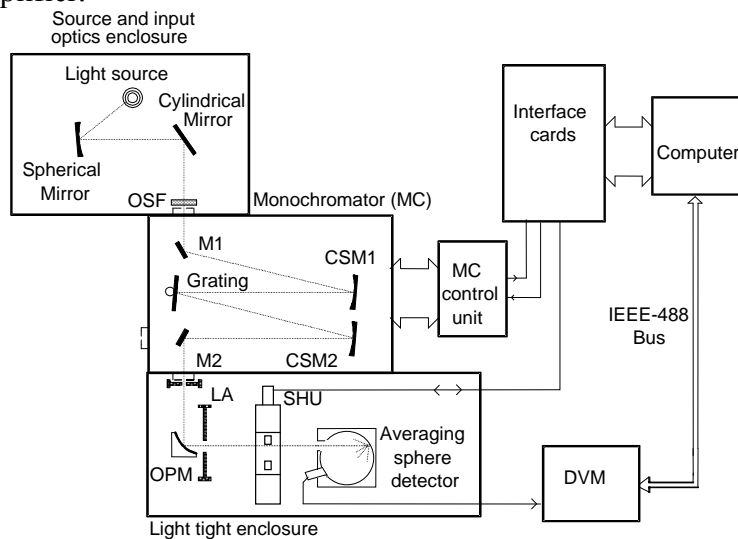

Figure 10 - Schematic of spectrometer for transmittance measurements. OSF, order-sorting filter; M1, M2, flat mirrors; CSM1, CSM2, collimating spherical mirrors; LA, limiting apertures (iris diaphragm), OPM, off-axis parabolic mirror; SHU, sample-holder unit; DVM, digital volt meter.

Description of the measuring technique

The bandpass of the instrument was set to 1.0 nm for the measurements at the visible wavelengths and to 2.0 nm at the NIR wavelengths. Four individual sets of measurements were carried out on the filters. From one set to the other, the filters are rotated clockwise by 90

degrees. For one orientation of the filters at a wavelength setting, the sequence is m times ($I_b, I_o, I_s, I_s, I_o, I_b$). Symbols I_b, I_o and I_s denote respectively the signal readings for the detector dark current, for the beam intensity through an empty space, and for signal reading for the transmitted beam through filter. The number of passes was usually chosen as $m = 5$. Two consecutive readings were taken for each individual sample so that the detector exposure times were equal for the partial and full beam intensity. The average value of the two I_{sj} readings is denoted by \bar{I}_{sj} ($j=1, 2$). The signal-reading data were processed by taking the average values of two I_b readings and the closest I_o readings on both sides of I_{sj} readings, giving mean values \bar{I}_b and \bar{I}_{oj} . Then the transmittance T_j was computed for each filter according to

$$T_j = \frac{\bar{I}_{sj} - \bar{I}_b}{\bar{I}_{oj} - \bar{I}_b}.$$

The transmittance values for the m passes were then averaged to obtain \bar{T}_j .

Description of calibration laboratory conditions

The ambient temperature of the laboratory was 23 ± 1 °C.

Comments on filters

When received, the filters were clean except for a few minor stains and some dust particles attached to the surfaces of the filters. We used a soft brush to remove the dust particles. No effort was made to remove the dirt stains.

Uncertainties

The uncertainties are absolute uncertainties.

Table 23 : Type A uncertainties

λ (nm)	Filter "A"	Filter "B"	Filter "C"	Filter "D"	Filter "E"
380	1,00E-04	1,00E-04	2,00E-05	5,00E-07	5,00E-07
400	5,00E-05	1,00E-04	3,00E-05	5,00E-07	5,00E-07
500	1,50E-04	5,00E-05	5,00E-06	1,50E-06	2,00E-06
600	1,00E-04	1,00E-04	2,50E-05	1,50E-06	1,00E-06
700	1,00E-04	5,00E-05	2,50E-05	2,50E-06	2,50E-06
800	1,00E-04	5,00E-05	1,50E-05	2,00E-06	1,50E-06
900	5,00E-05	5,00E-05	3,00E-05	2,50E-06	2,50E-06
1000	5,00E-05	5,00E-05	3,50E-05	3,00E-06	3,00E-06

Table 24 : Type B uncertainties

λ (nm)	Filter "A"	Filter "B"	Filter "C"	Filter "D"	Filter "E"
380	6,00E-04	6,00E-04	1,30E-04	1,40E-05	4,00E-06
400	4,00E-04	4,00E-04	9,00E-05	5,00E-06	2,00E-06
500	3,00E-04	3,00E-04	7,00E-05	7,00E-06	2,00E-06
600	3,00E-04	3,00E-04	7,00E-05	9,00E-06	2,00E-06
700	3,00E-04	3,00E-04	1,20E-04	2,10E-05	5,00E-06
800	3,00E-04	3,00E-04	1,10E-04	2,50E-05	8,00E-06
900	4,00E-04	3,00E-04	9,00E-05	2,00E-05	8,00E-06
1000	4,00E-04	3,00E-04	7,00E-05	1,50E-05	7,00E-06

4.10. MKEH

Assigned set : #30

Make and Type of the spectrophotometer

The spectrophotometer used for the comparison measurement at MKEH was developed in-house.

OMH'S SPECTROPHOTOMETER LAYOUT

- 1-Lightsource
- 2-Power supply
- 3-Monochromator
- 4-Cut-off filter
- 5-Input optic
- 6-Flat mirror
- 7-Thermostat
- 8-Filter wheel
- 9-Printer
- 10-Integrating sphere
- 11-Photomultiplier-tube
- 12-High-voltage power supply
- 13-Photocurrent meter
- 14-Wavelength drive
- 15-Limiting aperture
- 16-Shutter
- 17-Si-detector

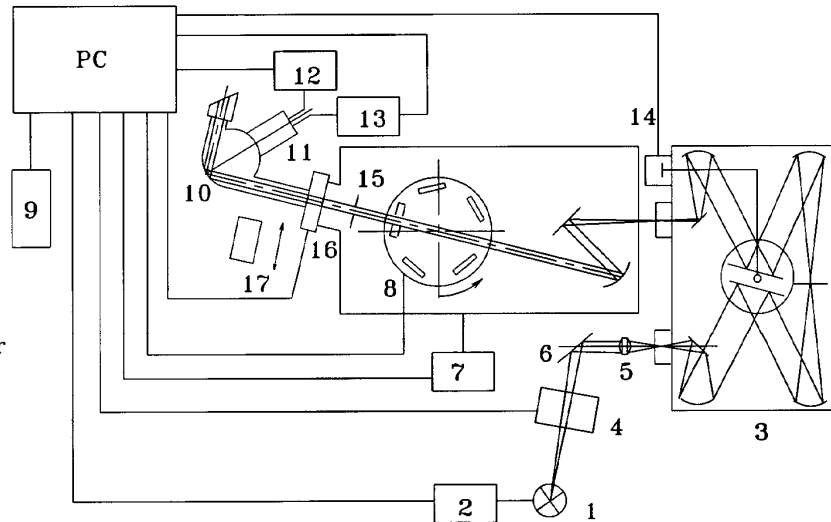

Figure 11

The spectrophotometer is computer controlled. It is based on a Hilger-Watts double grating monochromator (3) with UV; VIS; NIR grating-pairs. A deuterium lamp is used for the UV spectral range and a tungsten strip lamp for the VIS-NIR spectral range as light source. Four samples (8) can be measured in a thermostated, light-tight box. An off-axis parabolic mirror makes possible the nearly parallel beam. The measured area is determined by the limiting aperture (15), which is located just behind the samples. A Si photodiode (17), or a photomultiplier (11) with an integrating sphere (10), is used as a detector depending on the spectral range and transmittance level. A built in He-Ne laser makes easier the sample alignment. The spectrophotometer can be characterized with the following data :

- sample alignment: - $< 20^\circ$
- beam divergence: - $< 30^\circ$
- regular power range for the direct beam: - $1\text{ nW} - 1\mu\text{W}$, depending on the wavelength
- dynamic range : - $10^5 - 10^7$, - depending on the wavelength
- wavelength accuracy is better than 0.2 nm
- measuring method : automatically repeated measurements accepted only if the results agreed within a given tolerance.

The wavelength is calibrated with Hg, Ne and Kr line sources.

The samples are aligned with the help of a laser.

The polarisation is measured with the help of a polarizer.

The current to voltage converter was characterized with a current generator.

The linearity of the system was measured with the double-aperture method.

Description of the measuring technique

The filters were measured with tungsten source, with UV and VIS pairs of grating, with Si and PMT detectors, with different high voltage and with measuring area of 4-8 mm in diameter. In the case of filter 30D and 30E the measurement was made with cascade technique.

The samples were measured 5-23 times. They were aligned at each run. Each run corresponds to the average of 10-50 measurements. The reported repeatability corresponds to the standard deviation of the different runs.

The measurements were made according to the following procedure :

- First the filters were measured with the PMT and with the VIS pair of gratings in the spectral range of 380 nm to 800 nm. The samples were measured in each position of the filter wheel. First they were measured with an 8 mm diameter beam spot, then over circles of 5, 6 mm and 4 mm diameter. For filters 30D and 30E the measurement was made using the cascade technique.
- Second the filters were measured with the Si detector and with the VIS pair of gratings in the spectral range of 400 nm to 900 nm. The samples were measured in each position of the filter wheel. Again they were measured first over an 8 mm diameter circle then over circles of 5, 6 mm and 4 mm diameter.
- Third the filters were measured with the PMT and with the IR pair of gratings in the spectral range of 700 nm to 800 nm.. The samples were measured in each position of the filter wheel. They were measured with an 8 mm diameter beam spot.
- Finally the filters were measured with the Si detector and with the IR pair of gratings in the spectral range of 700 nm to 1000 nm. The samples were measured in each position of the filter wheel. They were measured with an 8 mm diameter beam spot.

Some measurements were repeated and the measurements from the 4 independent runs were equally weighted.. Measurements having too high an uncertainty were not included in the unweighted average.

Description of calibration laboratory conditions

The laboratory has an air-conditioning system. The room temperature was measured during the measurements. A lot of runs were made overnight. The humidity was not controlled and was not continuously measured. It was checked and was estimated to be below 35% during the measurements.

Comments on filters

The filters were not cleaned.

Uncertainties

The uncertainties are absolute uncertainties

Table 25 : Type A uncertainties

λ (nm)	Filter "A"	Filter "B"	Filter "C"	Filter "D"	Filter "E"
380	4,00E-04	1,60E-04	9,00E-05	3,00E-05	6,00E-06
400	3,00E-04	1,80E-04	7,00E-05	3,00E-05	5,00E-06
500	3,00E-04	1,50E-04	6,00E-05	2,00E-05	4,00E-06
600	3,00E-04	1,00E-04	5,00E-05	2,00E-05	3,00E-06
700	5,00E-04	8,00E-05	6,00E-05	2,00E-05	8,00E-06
800	5,00E-04	9,00E-05	7,00E-05	5,00E-05	1,00E-05
900	7,00E-04	9,00E-05	7,00E-05	5,00E-05	1,10E-05
1000	9,00E-04	1,60 ^E -04	9,00E-05	5,00E-05	1,30E-05

Table 26 : Type B uncertainties

λ (nm)	Filter "A"	Filter "B"	Filter "C"	Filter "D"	Filter "E"
380	8,06E-04	7,12E-04	1,44E-04	3,08E-05	6,71E-06
400	7,42E-04	7,18E-04	1,44E-04	2,79E-05	7,48E-06
500	7,42E-04	7,14E-04	1,37E-04	2,99E-05	6,93E-06
600	7,42E-04	7,13E-04	1,41E-04	2,87E-05	7,42E-06
700	7,48E-04	7,16E-04	1,37E-04	2,87E-05	7,55E-06
800	7,48E-04	7,14E-04	1,44E-04	2,52E-05	6,63E-06
900	7,14E-04	7,14E-04	1,44E-04	2,94E-05	6,93E-06
1000	7,94E-04	7,12E-04	1,44E-04	3,49E-05	7,48E-06

4.11. NPL

Assigned set : #4

Make and Type of the spectrophotometer:

The facility is automated and controlled by a PC. A Heidenhain ROD800 rotary encoder is fitted to the spindle of the output grating table, and the encoder readings are used in the calibration of the wavelength scale.

The monochromator is a double-grating Jobin-Yvon HRD1 monochromator, with additive dispersion from a Czerny-Turner mounting. Three pairs of gratings are used to cover the spectral regions 200 nm to 1000 nm, 500 nm to 2000 nm, 1000 nm to 4000 nm. The dispersions in the middle of these ranges are 1.2, 2.4 and 4.8 mm·nm⁻¹ with blaze wavelengths of 250 nm, 1000 nm and 2000 nm respectively.

The light emerging from the monochromator is collimated with reflective optics. A four-leafed aperture is used to define the patch size

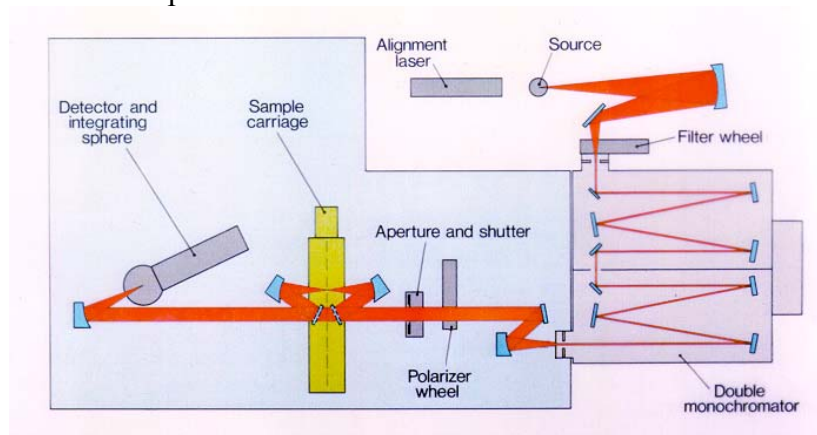

Figure 12 Schematic of facility with the PMT and sphere assembly. Ancillary optics used to produce focussed radiation at the sample are also shown.

The facility has two sources, Polaron 25G tungsten ribbon lamp, region of use 300 nm to 4000 nm and a Cathodeon R07 deuterium lamp, region of use 200 nm to 350 nm.

The facility has 4 detectors:

- a Thorn-EMI 9558QA S20 photomultiplier tube behind a baffled 100 mm diameter Spectralon integrating sphere, region of use 200 nm to 700 nm ;
- a Hamamatsu S1337 silicon photodiode, region of use 200 nm to 1000 nm;
- a Germanium Power Devices GAP5000 InGaAs detector, region of use 900 nm to 1500 nm;
- a liquid-nitrogen cooled Judson J10D InSb detector with a cold filter, region of use 1000 nm to 2800 nm.

Description of the measuring technique

Measurements were carried out using time-symmetric measurement sequences. The comparison artefacts (A04, B04, C04, D04, E04) were measured relative to air. E04 was measured relative to D04 at 380 nm and 400 nm and its transmittance relative to air calculated using $T(E04) = T(E04/D04) \times T(D04)$.

The measurement sequences comprised the following individual measurement settings: S – sample in beam, R – reference (air or D04) in beam, D – dark (shutter closed). For each setting an average of 70 DVM readings was taken.

The normal sequence used was {D [(R S) x 9] R D}, but for measurements of D04 and E04/D04 at 380 nm and 400 nm, the sequence {D [(R S R D) x 9]} was used. There was no change of amplifier gain setting within a measurement sequence.

Grating pair I were used for measurements from 380 nm to 600 nm, and grating pair II for measurements from 700 nm to 1000 nm. The photomultiplier tube and integrating sphere was used for measurements at 380 nm and 400 nm, and the silicon photodiode was used for measurements at 500 nm to 1000 nm.

Measurements were carried out with the sample rotated by 2° about the vertical axis (the monochromator plane is horizontal) and the transmittance at normal incidence was calculated using the standard expressions in the literature. The spectral bandwidth used was 1 nm.

Description of calibration laboratory conditions

The temperature in the sample compartment was $(24.5 \pm 1)^\circ\text{C}$. The humidity was $(20.5 \pm 1.5) \%$

Comments on filters

Small mark on filter E. May need to be cleaned.

Uncertainties

The uncertainties are absolute uncertainties

Table 27 : Type A uncertainties

λ (nm)	Filter "A"	Filter "B"	Filter "C"	Filter "D"	Filter "E"
380	3,90E-05	1,05E-04	2,60E-05	3,00E-06	1,10E-07
400	4,80E-05	6,90E-05	3,20E-05	4,00E-06	4,00E-07
500	3,20E-05	5,50E-05	1,70E-05	3,00E-06	5,00E-07
600	1,60E-05	8,10E-05	2,90E-05	6,00E-06	1,10E-06
700	4,80E-05	5,40E-05	7,00E-06	6,00E-06	7,00E-07
800	1,10E-05	3,80E-05	1,20E-05	5,00E-06	3,00E-07
900	7,50E-05	9,30E-05	9,00E-06	4,00E-06	7,00E-07
1000	1,17E-04	1,25E-04	6,00E-06	3,00E-06	9,00E-07

Table 28 : Type B uncertainties

λ (nm)	Filter "A"	Filter "B"	Filter "C"	Filter "D"	Filter "E"
380	3,50E-05	1,49E-04	4,70E-05	2,00E-06	1,70E-07
400	5,00E-05	4,10E-05	2,80E-05	5,00E-06	4,00E-07
500	2,60E-05	2,60E-05	1,20E-05	5,00E-06	2,20E-06
600	2,60E-05	2,50E-05	1,10E-05	2,00E-06	8,00E-07
700	4,20E-05	3,50E-05	2,90E-05	1,40E-05	4,50E-06
800	3,30E-05	4,10E-05	2,20E-05	1,20E-05	7,30E-06
900	2,80E-05	3,10E-05	1,50E-05	7,00E-06	4,90E-06
1000	2,90E-05	2,60E-05	1,10E-05	8,00E-06	5,30E-06

4.12. PTB

Assigned set: #3

Make and Type of the spectrophotometer:

A self-built reference spectrophotometer was used consisting of lamp section, single-pass double monochromator (Jobin Yvon HRD1, focal length $f = 0.6$ m), beam-forming chamber, and detection chamber (see Figure 13).

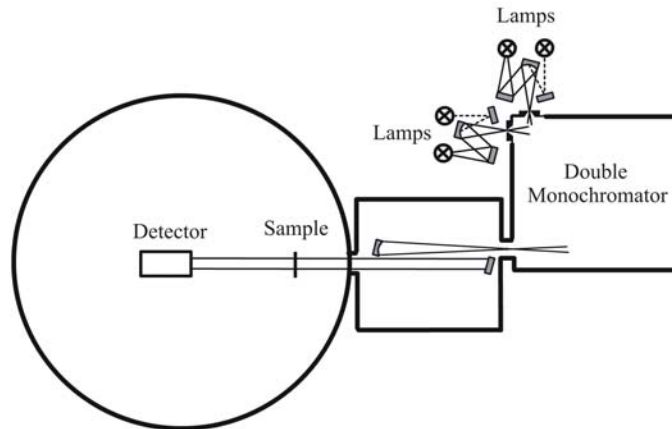

Figure 13 - Sketch of the spectrophotometer set-up for the measurement of regular transmittance

In this study a tungsten halogen lamp was used for the transmittance measurements, a HeNe laser for alignment, and the laser and a mercury spectral lamp for checking the wavelength calibration. From 380 nm to 800 nm the 1200 lines/mm grating was used, giving a spectral bandwidth of 1,0 nm. For wavelength 900 and 1000 nm, the 600 lines/mm grating was used, corresponding to a 2,1 nm bandwidth.

The beam was formed to be parallel with a diameter of 20 mm at the sample. The residual divergence was in horizontal direction $\theta_h = 0,15^\circ$ and for the vertical direction $\theta_v = 0,65^\circ$.

Normal incidence was used.

In the spectral range up to 800 nm a photomultiplier detector (EMI 9558), above 800 nm a cooled PbS detector (Hamamatsu 1908) was used.

Description of the measuring technique

The samples were fed into a computer controlled sample-holder which is able to carry five filters and has a sixth position for a reference filter or for the determination of the 100% signal, respectively. One cycle at a specific wavelength consists of the reading of the 100% value, the reading for up to five filters and the reverse process. The mean of both values for each of the six positions is calculated in order to cope for a drift of the lamp radiation. A complete measurement consists of up to 100 cycles at maximum. The number of cycles of the individual measurements is given in the row named N of the result tables (tables 2 to 6).

The samples were not cleaned, only dust stemming from the wooden sample box was blown off by clean and dry nitrogen gas.

Description of calibration laboratory conditions

The temperature during the measurements was controlled by the air conditioning system of the laboratory to be $23\text{ }^{\circ}\text{C} \pm 1\text{ }^{\circ}\text{C}$. The relative humidity also was controlled by this system and stabilised to lie below 55%.

Comments on filters

Sample A (BK7, thickness 4,0 mm) shows a distinct prismatic effect of about 0,06 cm/m stemming from a non-perfect parallelism of the surfaces. This results in a higher uncertainty with respect to the effect 'beam displacement'. Such a filter is not well suited for calibrations at a high level of precision.

The NG-type neutral density filters (especially samples C, D and E) have a steep absorption edge below 400 nm. The edge is also known to shift with temperature. Both aspects are in contrast to demand for spectral flatness and independence from environmental influences, which should be required from calibration standard. Precise calibrations at the wavelength of 380 nm cannot be expected to be performed for the NG-type filters and this particular wavelength should be excluded from the comparison.

The samples were not cleaned, only dust stemming from the wooden sample box was blown off by clean dry nitrogen gas.

Uncertainties

The uncertainties are absolute uncertainties

Table 29 : Type A uncertainties

λ (nm)	Filter "A"	Filter "B"	Filter "C"	Filter "D"	Filter "E"
380	5,10E-05	3,20E-05	3,30E-06	7,50E-07	2,00E-07
400	6,40E-05	6,80E-05	1,10E-05	1,70E-06	1,10E-06
500	6,10E-05	5,00E-05	7,80E-06	1,50E-06	1,20E-06
600	5,10E-05	6,10E-05	5,80E-06	1,50E-06	1,20E-06
700	5,80E-05	5,00E-05	1,30E-05	2,90E-06	1,40E-06
800	1,40E-04	1,20E-04	3,50E-05	7,70E-06	2,90E-06
900	1,10E-04	6,50E-05	2,70E-05	2,30E-05	2,20E-05
1000	5,80E-05	4,90E-05	1,40E-05	9,50E-06	9,10E-06

Table 30 : Type B uncertainties

λ (nm)	Filter "A"	Filter "B"	Filter "C"	Filter "D"	Filter "E"
380	4,93E-04	7,21E-04	9,42E-05	2,91E-06	1,51E-07
400	4,89E-04	6,13E-04	2,18E-04	1,72E-05	1,41E-06
500	4,89E-04	6,01E-04	2,11E-04	2,71E-05	2,01E-06
600	4,86E-04	6,11E-04	2,10E-04	2,71E-05	2,00E-06
700	4,86E-04	5,82E-04	3,94E-04	6,34E-05	1,60E-05
800	4,86E-04	6,43E-04	3,97E-04	1,11E-04	2,75E-05
900	1,80E-03	2,62E-04	1,35E-04	3,51E-05	1,80E-05
1000	1,80E-03	2,94E-04	1,05E-04	3,16E-05	1,06E-05

4.13. SMU

Assigned set : #11

Make and Type of the spectrophotometer

- Double beam UV-VIS spectrophotometer CARY 4E by Varian (the spectral transmittance primary standard equipment of SMU)
- Wavelength range: (175 to 900) nm
- Monochromator: double out-of-plane Littrow monochromator
- Grating: 70 mm x 45 mm, 1200 lines/mm, blazed at 250 nm (blaze angle 8.5°, reciprocal dispersion 0.98 nm/mm)
- High-order rejection: filter (WG320, OG530, RG780)
- Beam splitting system: chopper (30 Hz)
- Detection system: high performance R928 PMT
- Sources: tungsten halogen visible source with quartz windows
deuterium arc UV source
- Diameter of the illum. area: 5.1 mm
- Collimating optics: spherical mirrors
- Beam details: Polarisation: identical reference and sample beam (beams partially polarised only)
Vertical f number 7.2
Horizontal f number 9
Maximum vertical angle of incidence on sample 7.61°
Maximum horizontal angle of incidence on sample 3.22°
Image sizes at centre of sample compartment:
Full height slit (13.35 mm x 5.1 mm wide
5 nm spectral bandwidth (SBW)

Description of the measuring technique

Five sets of measurements have been done. For each set, the 5 filters are measured, starting with the filter A and ending with the filter E. Within the set, 10 consecutive measurements are performed per filter. Each measurement consists of a measurement of the instrument zero, the reference and the filter.

Description of calibration laboratory conditions

Ambient temperature: (23 ± 2) °C
Relative humidity: (50 ± 10) %

Comments on filters

The filter reference N° A11 was cleaned with ethanol (purity UV) before measurements. In case of accidental pollution during measurements all filters (reference N° A11, B11, C11, D11 and E11) were cleaned with a special paper for optical glass or with brush for optics.

Uncertainties

The uncertainties are absolute uncertainties.

Table 31 : Type A uncertainties

λ (nm)	Filter "A"	Filter "B"	Filter "C"	Filter "D"	Filter "E"
380	1,66E-05	5,34E-05	9,79E-06	2,21E-06	4,76E-07
400	2,88E-05	7,60E-05	1,19E-05	4,55E-06	7,91E-07
500	5,22E-05	6,95E-05	2,04E-05	3,10E-06	8,61E-07
600	4,52E-05	4,99E-05	2,83E-05	6,08E-06	1,43E-06
700	3,90E-05	4,82E-05	3,12E-05	4,08E-06	4,43E-06
800	3,89E-05	3,61E-05	2,62E-05	4,07E-06	3,74E-06
900	9,75E-05	4,92E-05	2,58E-05	1,13E-05	5,25E-06
1000	1,66E-05	5,34E-05	9,79E-06	2,21E-06	4,76E-07

Table 32 : Type B uncertainties

λ (nm)	Filter "A"	Filter "B"	Filter "C"	Filter "D"	Filter "E"
380	1,40E-04	1,43E-04	3,55E-05	3,11E-06	2,01E-06
400	1,40E-04	1,40E-04	9,21E-05	1,30E-05	2,91E-06
500	1,40E-04	1,40E-04	9,00E-05	1,90E-05	4,31E-06
600	1,40E-04	1,40E-04	8,20E-05	1,90E-05	4,50E-06
700	1,40E-04	1,40E-04	1,20E-04	4,16E-05	1,20E-05
800	1,40E-04	1,40E-04	1,20E-04	4,80E-05	1,90E-05
900	1,40E-04	1,40E-04	9,60E-05	3,70E-05	1,80E-05
1000	1,40E-04	1,43E-04	3,55E-05	3,11E-06	2,01E-06

4.14. SP

Assigned set : #28

Make and Type of the spectrophotometer:

- Measurement equipment : spectrophotometer Perkin-Elmer Lambda 900 in basic set-up.
- Spot position : centre of sample
- Irradiation spot size : about 1 mm x 10 mm
- Bandwidths : 1 nm for 380 nm to 800 nm, 4.4 nm for 900 nm and 2.2 nm at 1000 nm.

Description of the measuring technique

Regular transmittance was measured at the eight wavelengths with the spectrophotometer set in Wp-mode, i.e.; only set to measure the eight calibration wavelengths. Transmittances lower than 0,01 (1 % T) were measured with the attenuator in the reference beam set to 1 % T and set to 100 % for higher transmittance. The depolariser in the spectrophotometer was activated. A 2 s integration time was used for the six shorter wavelengths for which a PMT detector was used and 10 s for the two longer where a PbS detector was used. Ten series (in a few cases 7 or 9) of measurements were taken with a day or half a day between each. Before each series the spectrophotometer 100 % and 0 % base lines were readjusted. In the special case of a 1 % attenuator in the reference beam, the 100 % base line was measured and corrected for, which is the normal procedure of the laboratory for those measurements.

Description of calibration laboratory conditions

Ambient temperature : (23 to 24) °C

Temperature of the filter : (25.0 ± 0.5) °C

Comments on filters

No comments.

Uncertainties

The uncertainties are absolute uncertainties.

Table 33 : Type A uncertainties

λ (nm)	Filter "A"	Filter "B"	Filter "C"	Filter "D"	Filter "E"
380	9,13E-04	2,47E-04	2,76E-05	5,39E-07	1,56E-07
400	1,01E-03	1,82E-04	4,72E-05	5,68E-06	7,25E-07
500	9,17E-04	1,87E-04	5,47E-05	5,89E-06	1,34E-06
600	1,01E-03	1,83E-04	5,34E-05	6,64E-06	1,54E-06
700	1,01E-03	1,91E-04	8,00E-05	1,57E-05	6,64E-06
800	1,01E-03	3,47E-04	8,93E-05	2,23E-05	2,06E-05
900	4,61E-04	1,53E-04	1,35E-04	1,30E-04	6,86E-05
1000	3,69E-04	1,38E-04	1,39E-04	1,18E-04	5,98E-05

Table 34 : Type B uncertainties

λ (nm)	Filter "A"	Filter "B"	Filter "C"	Filter "D"	Filter "E"
380	6,13E-04	1,17E-03	2,48E-04	8,98E-06	4,33E-07
400	4,44E-04	7,79E-04	2,35E-04	2,23E-05	2,39E-06
500	6,07E-04	7,78E-04	1,92E-04	2,12E-05	3,12E-06
600	4,34E-04	8,81E-04	1,93E-04	2,51E-05	3,80E-06
700	4,32E-04	8,79E-04	4,02E-04	7,84E-05	1,99E-05
800	4,32E-04	9,38E-04	4,10E-04	1,08E-04	3,19E-05
900	1,11E-03	1,59E-03	5,64E-04	9,32E-05	1,37E-05
1000	1,14E-03	1,59E-03	4,17E-04	2,39E-05	4,38E-06

4.15. UME

Assigned set : #13

Make and Type of the spectrophotometer:

The spectrophotometer used was based on a double monochromator manufactured by Bentham Instruments Ltd, model DTM 300V. It was associated with an integrating sphere of 20 cm in diameter coated with BaSO₄. The light source was a 250 W quartz halogen lamp. The detector was an UV-enhanced silicon photodiode from EG&G, type UV-444BQ with an active area of 1 cm². The signal recovery was done by a lock-in amplifier with current pre-amplifier manufactured by Bentham Instruments Ltd, model 277-225. The signal readout was done by a digital multimeter manufactured by Keithley, model 2001, 6.5 digits. The spectral bandwidth was 1 nm.

Description of the measuring technique

The spectral transmittance measurements for all filters were performed at the wavelengths of 380 nm, 400 nm, 500 nm, 600 nm, 700 nm, 800 nm, 900 nm, and 1000 nm stated in the technical measurement protocol. A circular beam of about 21 mm diameter was used to eliminate flux non-uniformities during the measurements. The spectral transmittance set-up had been modified to meet the parallel beam requirement. Filters were located normal to the propagation direction of the incoming optical signal. Apertures were used through the beam path to minimize the background and stray light. An integrating sphere was used to collect the filtered light. The spectral transmittance value of each filter was obtained from a set of runs taken in the same day (morning and afternoon) and of repeat measurements the following week. Before calculating spectral transmittance values, the background correction was applied to all measured signals.

Description of calibration laboratory conditions

Ambient temperature : (23 ± 0.5) °C
Relative humidity : (45 ± 5.0) %

Comments on filters

Each filter was inspected for damage and contamination before the measurements. No special cleaning process was applied especially during the measurements, apart from slight polishing with a soft cloth if necessary before start.

Uncertainties

The uncertainties are absolute uncertainties.

Table 35 : Type A uncertainties

λ (nm)	Filter "A"	Filter "B"	Filter "C"	Filter "D"	Filter "E"
380	2,04E-04	1,57E-03	3,53E-04	9,55E-06	2,60E-05
400	1,81E-04	2,67E-04	1,89E-04	5,60E-06	2,89E-05
500	3,85E-04	9,67E-05	9,70E-05	1,30E-05	3,16E-06
600	3,66E-04	7,97E-05	2,43E-05	3,35E-06	1,25E-05
700	4,19E-04	2,17E-04	7,79E-05	1,45E-05	1,21E-05
800	1,34E-04	4,27E-04	1,47E-04	1,76E-05	2,40E-06
900	3,74E-04	2,31E-04	8,62E-05	1,56E-05	2,68E-05
1000	4,72E-04	1,91E-04	2,58E-04	4,47E-05	6,66E-05

Table 36 : Type B uncertainties

λ (nm)	Filter "A"	Filter "B"	Filter "C"	Filter "D"	Filter "E"
380	8,48E-05	8,56E-05	7,65E-05	3,37E-05	2,40E-05
400	6,38E-05	7,07E-05	7,04E-05	3,41E-05	2,44E-05
500	4,87E-05	5,20E-05	6,01E-05	3,02E-05	2,33E-05
600	4,91E-05	5,25E-05	5,21E-05	2,96E-05	2,29E-05
700	7,54E-05	7,40E-05	5,67E-05	5,14E-05	2,31E-05
800	1,03E-04	9,97E-05	6,84E-05	4,55E-05	2,24E-05
900	1,31E-04	1,27E-04	8,35E-05	5,06E-05	2,25E-05
1000	1,59E-04	1,54E-04	1,01E-04	5,90E-05	2,30E-05

4.16. VSL

Assigned set: #8

Make and Type of the spectrophotometer

The measurements have been performed using a double grating monochromator in additive dispersion mode (Type: 2035, McPherson, $f = 350$).

The operational details were:

Wavelength range:	380 nm to 1000 nm
Grating type:	ruled
f- number:	4
Lines/mm:	1200

Inverse linear dispersion:	1.0 nm/mm
Slit width:	2 mm
Bandwidth:	2 nm
Spot size at filter:	4,4 mm

For the measurements a tungsten halogen lamp was used, Type Osram Xenophot HLX 250 W. Owing to the low power at 380 nm combined with the low transmittance of the filter, an additional Argon-Maxi-Arc source was used in the range from 380 nm to 500 nm. Both sources were imaged on the entrance slit of the monochromator using a quartz lens. A shutter and an order-selection filter were placed at the entrance slit.

The monochromator was calibrated using low pressure spectral lamps, Cs and He-filled.

The exit slit is imaged on the filter under test by three mirrors. The mirrors increase the f-number from the monochromator to 8 on the filter; the image from the exit slit is increased with a factor 2,2.

The light transmitted through the filter is imaged with a flat mirror and a quartz lens on a silicon detector, Type S1337-1010BQ, Hamamatsu. The filter is positioned on a translation stage which allows horizontal and vertical displacement and rotation around the vertical axis. Part of the light from the exit slit is directed, using a beam splitter, on to a monitor detector of the same type as the latter. The monitor detector is used to compensate for drift of the source.

The photocurrents of both detectors were measured using two Keithley 486 Picoampmeters, which were calibrated by the Electrical Department of NMi/VSL in September 1999 and re-calibrated in September 2000. No drift between the calibrations and the re-calibrations was observed.

Description of the measuring technique

Before a transmittance measurement, the monochromator was calibrated using the Cs spectral lamp. After the measurements this calibration was checked with both the Cs and He lamps.

The filter dimensions were 50 mm by 50 mm with a thickness variation from 1,5 mm to 4,0 mm. The filter was measured with a spot of 4,4 mm. Horizontal, vertical and rotational scans over the filter were performed to measure the inhomogeneity of the filter and the influence of the angle of incidence. These variables are taken in account as uncertainties.

The final measurements were taken in mostly 13 runs, in a period of several days. The transmittance of the filters was measured using nearly monochromatic light with and without the filter in its path.

Description of calibration laboratory conditions

The ambient conditions during the measurements were : $T = (25.0 \pm 0.5) ^\circ\text{C}$ and $\text{RH} = (45 \pm 10) \%$.

Uncertainties

The uncertainties are absolute uncertainties.

Table 37 : Type A uncertainties

λ (nm)	Filter "A"	Filter "B"	Filter "C"	Filter "D"	Filter "E"
380	1,92E-04	3,67E-05	2,91E-05	3,17E-07	2,08E-08
400	1,46E-04	1,27E-04	8,21E-05	5,86E-06	2,56E-07
500	1,56E-04	6,83E-05	8,50E-05	1,32E-05	1,32E-06
600	1,19E-04	7,91E-05	3,60E-05	4,65E-06	7,90E-07
700	1,65E-04	1,21E-04	1,06E-04	3,11E-05	2,00E-06
800	9,20E-05	4,62E-05	9,25E-05	1,83E-05	1,38E-06
900	7,37E-05	6,03E-05	6,45E-05	1,32E-05	8,79E-07
1000	9,21E-05	5,45E-05	3,10E-05	4,48E-06	1,08E-06

Table 38 : Type B uncertainties

λ (nm)	Filter "A"	Filter "B"	Filter "C"	Filter "D"	Filter "E"
380	1,96E-04	1,02E-03	3,75E-04	2,37E-05	1,48E-06
400	1,10E-04	4,05E-04	1,85E-04	1,30E-05	1,28E-06
500	2,27E-04	4,29E-04	1,77E-04	2,13E-05	3,30E-06
600	1,40E-04	4,19E-04	1,76E-04	2,78E-05	5,24E-06
700	2,21E-04	4,29E-04	3,08E-04	6,41E-05	1,70E-05
800	1,59E-04	4,01E-04	2,89E-04	7,81E-05	3,21E-05
900	1,69E-04	3,46E-04	1,98E-04	5,45E-05	2,79E-05
1000	1,60E-04	3,13E-04	1,52E-04	4,13E-05	2,35E-05

5. Results

5.1. Notations

N	Number of participant NMIs, not counting the pilot laboratory (from p.10, we have $N = 16$).
$\tau_{X,i}$	Spectral transmittance of the filter type X (X varies from A to E), set i .
$u(\tau_{X,i})$	Total absolute uncertainty ($k=1$) of $\tau_{X,i}$ reported by the NMI.
$\tau_{X,i,r}^P$	Spectral transmittance of the filter type X (X varies from A to E), set i , measured by the Pilot. r is the round. $r = 1$ to 2, where $r=1$ is the measurement before dispatching and $r = 2$ is the measurement after dispatching.
$u(\tau_{X,i,r}^P)$	Total absolute uncertainty ($k=1$) of $\tau_{X,i,r}^P$ reported by the Pilot.
$u(\tau_{X,i,r}^{PR})$	Reproducibility (type A) of Pilot measurements for $\tau_{X,i,r}^P$.
Δ_{KCRV}	Reference value for the CCPR-K6 comparison. This is the difference between the transmittance value measured by the pilot laboratory and the transmittance value adopted as the KCRV.
$u(\Delta_{KCRV})$	Uncertainty in KCRV.

5.2. Pilot Measurements

The pilot measurements of all the filters involved in the comparisons for $r = 1$ and 2 are reported in Annex B

Annex B.1., Pilot laboratory transmittance measurements $\tau_{X,i,r}^P$ for $r = 1$ (p 76)

Annex B.2, Pilot laboratory transmittance measurements $\tau_{X,i,r}^P$ for $r = 2$ (p 77)

The adopted value for the pilot laboratory transmittance measurements is the average of round 1 and round 2

$$\tau_{X,i}^P = \frac{1}{2}(\tau_{X,i,1}^P + \tau_{X,i,2}^P) \quad (2)$$

All the values are in

Annex B.3, Pilot laboratory adopted transmittance $\tau_{X,i}^P$ (p 78)

The uncertainties associated are in Annex B.4 and Annex B.5, where:

Annex B.4, Pilot laboratory total uncertainty on adopted transmittance $u(\tau_{X,i}^P)$ (p79)

Annex B.5, Pilot laboratory “type A” uncertainty on adopted transmittance $u(\tau_{X,i}^{PR})$ (p80)

5.3. NMI Measurements

The participant laboratories’ measurements are reported in

Annex B.6, NMI absolute transmittance measurements $\tau_{X,i}$ (p81)

Annex B.7, NMI total absolute uncertainties on transmittance $u(\tau_{X,i})$ (p82)

5.4. Additional uncertainties

The additional uncertainties arise from artefacts due to transportation or different measurement conditions between Pilot and participants that affect comparison results. No problem was identified during the procedure that could suggest incorporating an additional uncertainty.

5.5. Drift uncertainty

As shown in §3.6, p.10, the stability of the filters during the comparison can be assessed by the difference between transmittance measurements before dispatching and after their return to the pilot laboratory. We plotted this difference for all the filters (see Figure 2 to Figure 6, p.11-13). It appears that the drift is quite smooth with respect to wavelength. As, for most filters, there are only 2 measurements at the pilot laboratory it is difficult to say much about the temporal changes

in the filters: it was decided that this was best taken into account by using the mean value of the transmittance measurements “before” and “after” at the pilot laboratory.

After discussion within the participants of the CCPR-K6, it was accepted that the uncertainty $u_{\text{drift}, X, i}$, associated with temporal drift of the filter X, i , is estimated to be within the difference “before” – “after” with a rectangular probability distribution.

$$u_{\text{drift}, X, i} = \frac{1}{2\sqrt{3}} |\tau_{X, i, 1}^P - \tau_{X, i, 2}^P| \quad (3)$$

For the pilot laboratory, the drift uncertainty is the average of all the filters.

$$u_{\text{drift}, X, 0} = \frac{1}{N} \sum_{i=1}^N u_{\text{drift}, X, i} \quad (4)$$

All the results concerning u_{drift} are reported in Annex B.8, p.83

5.6. Presentation of the results

For each NMI i for each filter X , the difference between NMI measurement and the pilot laboratory measurement (as the average of the two rounds) is given by:

$$\Delta_{X, i} = \tau_{X, i} - \tau_{X, i}^P \quad (5)$$

and its uncertainty, for $i=1$ to N by

$$u(\Delta_{X, i}) = \sqrt{u^2(\tau_{X, i}) + u^2(\tau_{X, i}^{\text{PR}}) + u_{\text{drift}, X, i}^2} \text{ without cut-off adjustment} \quad (6)$$

$\Delta_{X, i}$ and $u(\Delta_{X, i})$ are reported respectively in Annex B.9 and Annex B.10 (p. 84-85)

In the following calculations, the index X is omitted to simplify the notation, but the reader should keep in mind that the calculations are done for each of the five filters.

5.7. Key Comparison Reference Value (KCRV)

The KCRV and its uncertainty are given by the results of the CCPR-K6 comparison. They are reported in the following tables (tables 38 and 39 respectively of the CCPR-K6 Report).

Table 39 : Δ_{KCRV} for the five filters

λ (nm)	Filter “A”	Filter “B”	Filter “C”	Filter “D”	Filter “E”
380	4,357E-04	1,540E-03	1,211E-04	-1,599E-06	1,049E-06
400	3,701E-04	1,093E-03	-3,117E-05	-1,185E-05	-6,444E-09
500	3,234E-04	9,756E-04	1,156E-04	8,555E-06	2,954E-06
600	3,075E-04	7,611E-04	1,777E-04	4,101E-05	8,210E-06
700	4,225E-04	3,424E-04	9,633E-05	3,374E-05	7,620E-06
800	6,383E-04	2,010E-04	1,455E-05	6,546E-06	1,543E-05
900	5,228E-04	7,263E-05	8,838E-06	-4,104E-06	-2,187E-06
1000	4,211E-04	1,051E-04	-1,840E-06	-3,835E-06	-9,511E-06

Table 40 : $u(\Delta_{\text{KCRV}})$ for the five filters

λ (nm)	Filter “A”	Filter “B”	Filter “C”	Filter “D”	Filter “E”
380	1,058E-04	1,637E-04	3,114E-05	3,689E-06	2,379E-06
400	8,210E-05	1,187E-04	2,835E-05	4,792E-06	1,209E-06
500	6,338E-05	1,139E-04	2,193E-05	4,187E-06	1,125E-06
600	6,302E-05	6,358E-05	1,765E-05	4,668E-06	1,484E-06
700	6,926E-05	5,251E-05	2,987E-05	1,090E-05	4,124E-06
800	4,380E-05	5,879E-05	2,755E-05	8,918E-06	3,869E-06
900	6,047E-05	5,819E-05	1,978E-05	6,348E-06	3,015E-06
1000	6,443E-05	6,384E-05	1,555E-05	5,411E-06	2,903E-06

Uncertainties are absolute uncertainties.

6. Degrees of equivalence (DoE)

The linkage of this RMO key comparison to the CCPR-K6 Key Comparison takes a particularly simple form because (a) the pilot laboratory was also the pilot laboratory for the CCPR-K6 Comparison and (b) the five other laboratories serving as links between the two contributed the same measurements on the same artefacts in each comparison. It follows from (a) and (b) that the same result is obtained by linking through any one of these six laboratories or any combination of them. The degrees of equivalence of participants in this RMO key comparison can hence be evaluated by linking through values measured by the pilot laboratory. Because the CCPR KCRV is defined relative to the values obtained by the pilot laboratory and the $\Delta_{X,i}$ of this comparison are defined relative to measurements by the same pilot laboratory, the unilateral DoE of NMI i takes the simple form :

$$D_i = A_i - \Delta_{\text{KCRV}} \quad (7)$$

$$U_i = k \sqrt{u^2(\Delta_i) + u^2(\Delta_{\text{KCRV}})}; k=2 \quad (8)$$

Results are reported in Annex B.11 and Annex B.12 (p.86-87).

A graphical representation of the unilateral degrees of equivalence with $k=2$ is proposed in the followings pages.

Unilateral DoE of EUROMET-PR-K6 Participants Filter "A"

Values reported here are absolute.
Uncertainties are calculated with $k=2$.

*Nominal transmittance value : 92%

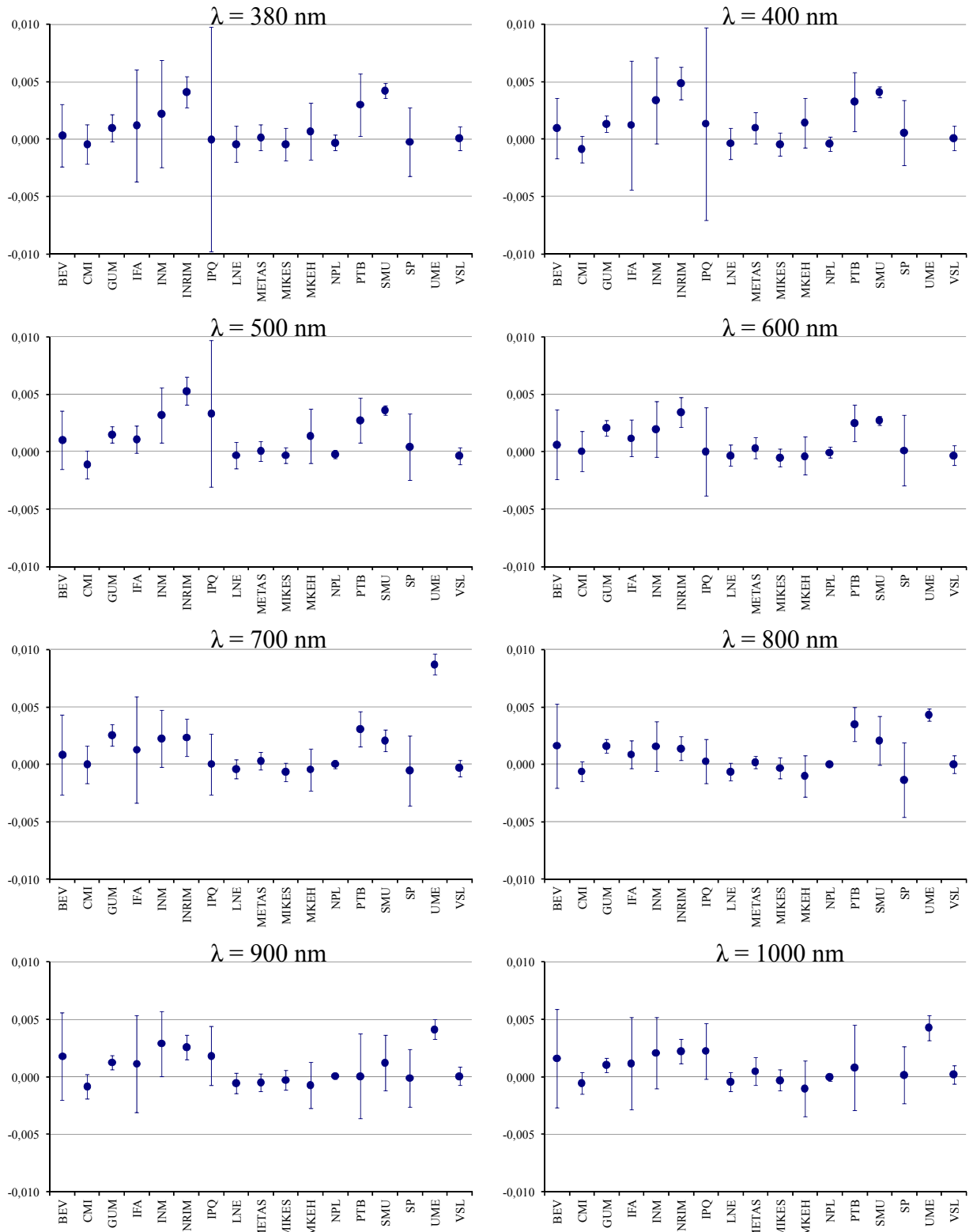

Figure 14 – DoE between laboratories and the KCRV for filter A

Unilateral DoE of EUROMET-PR-K6 Participants

Filter "B"

Values reported here are absolute.
Uncertainties are calculated with k=2.

*Nominal transmittance value : 56%

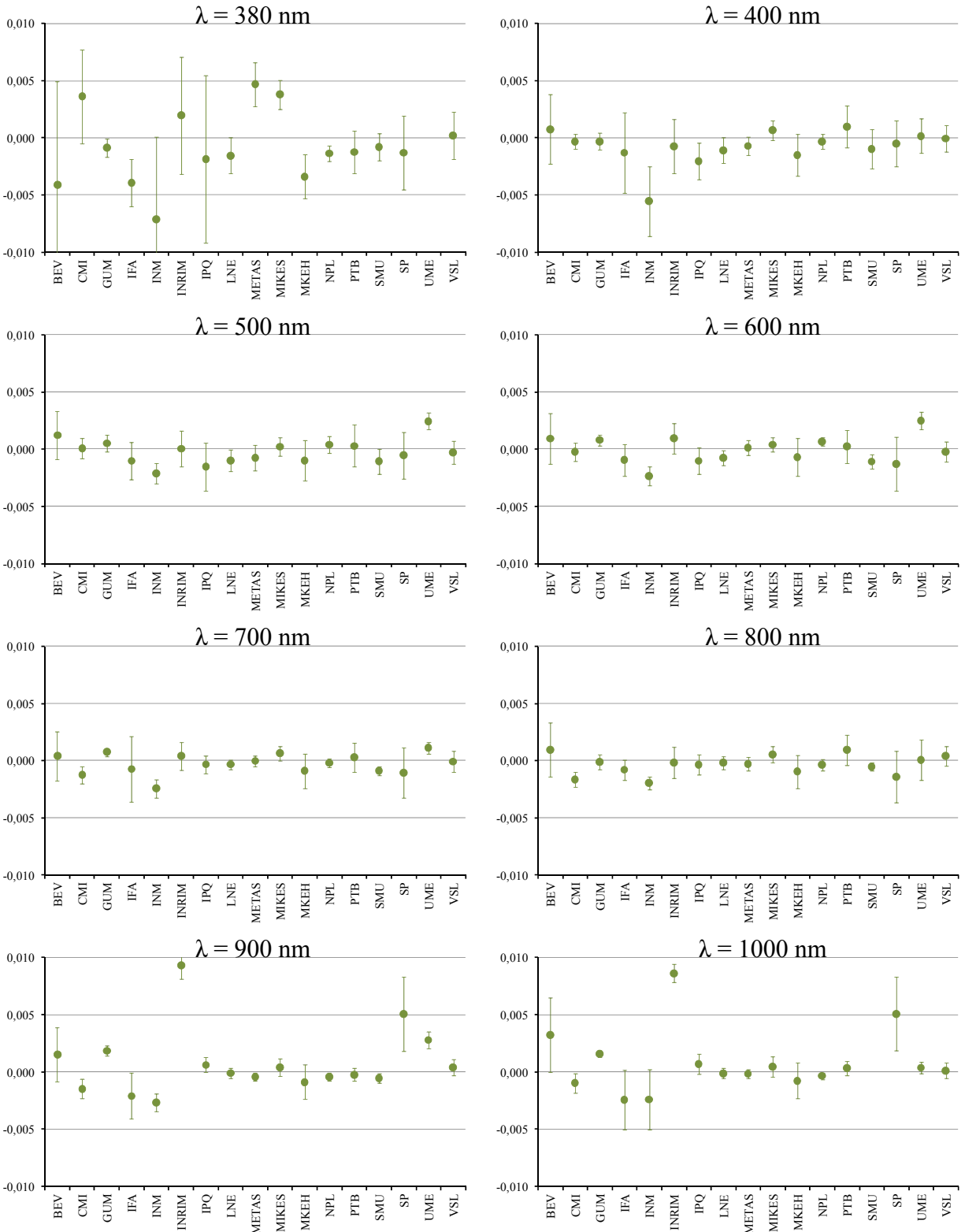

Figure 15 – DoE between laboratories and the KCRV for filter B

Unilateral DoE of EUROMET-PR-K6 Participants

Filter "C"

Values reported here are absolute.
Uncertainties are calculated with k=2.

*Nominal transmittance value : 10%

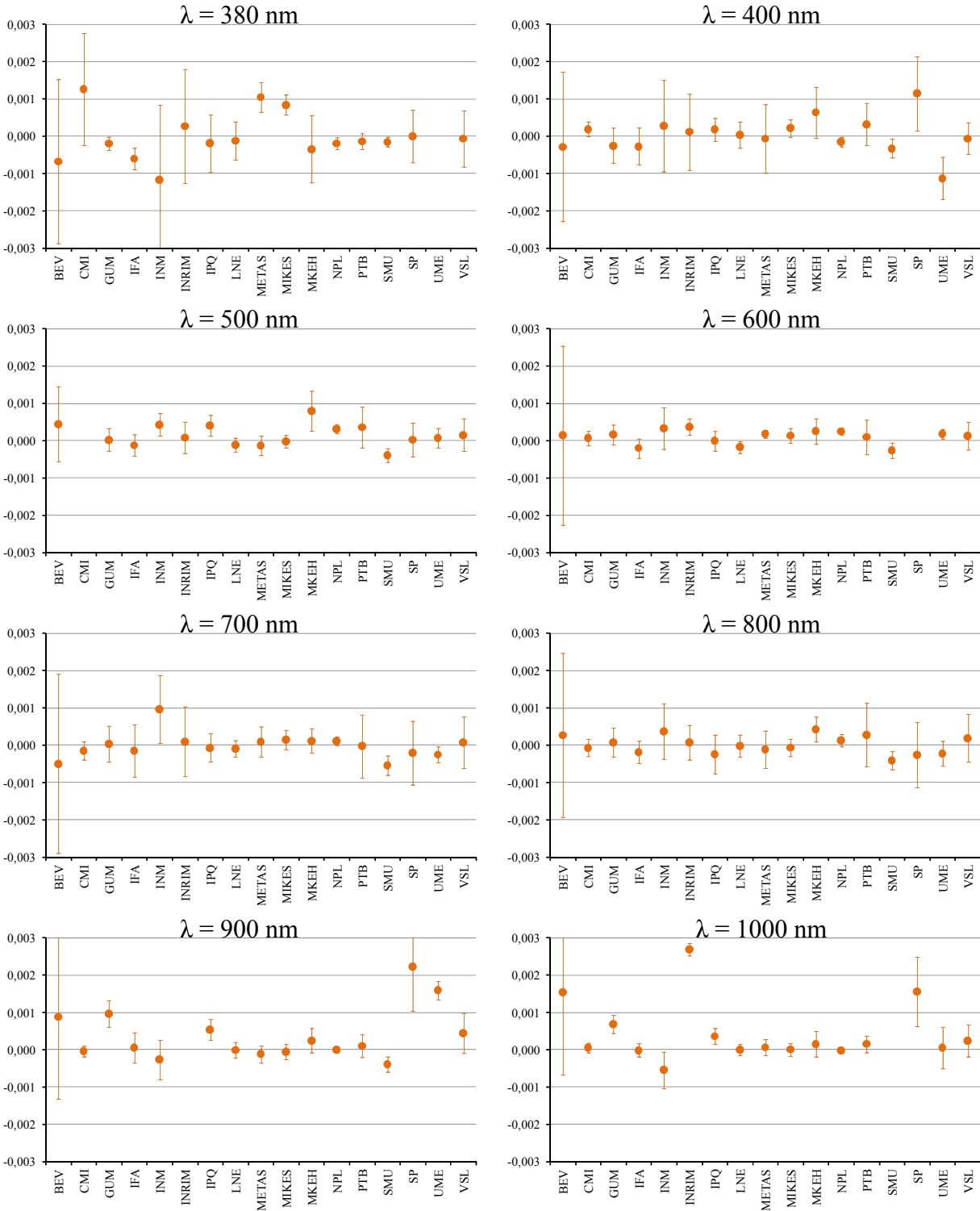

Figure 16 – DoE between laboratories and the KCRV for filter C

Unilateral DoE of EUROMET-PR-K6 Participants

Filter "D"

Values reported here are absolute.
Uncertainties are calculated with $k=2$.

*Nominal transmittance value : 1%

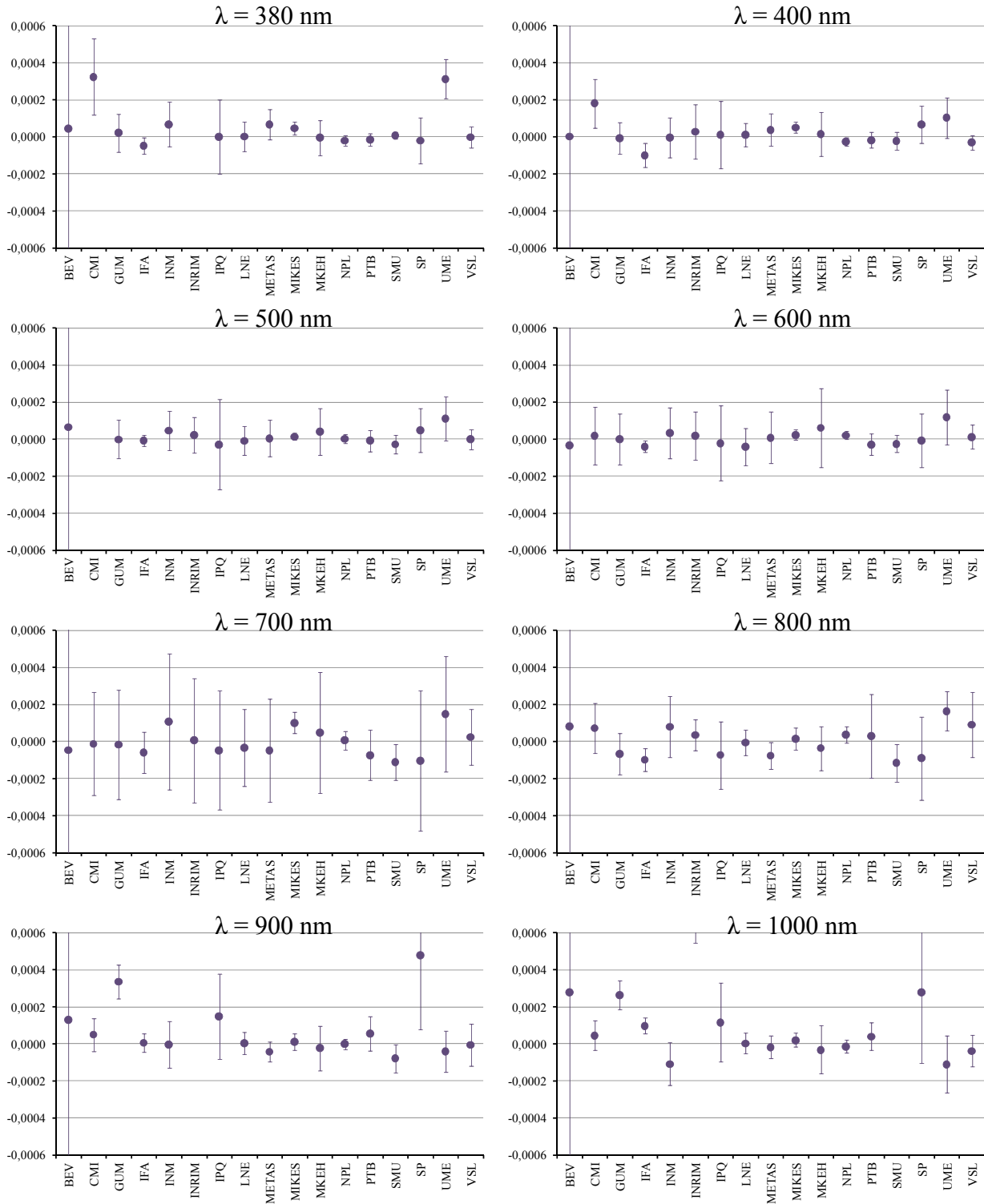

Figure 17 – DoE between laboratories and the KCRV for filter D

Unilateral DoE of EUROMET-PR-K6 Participants

Filter "E"

Values reported here are absolute.
Uncertainties are calculated with k=2.

*Nominal transmittance value : 0,1%

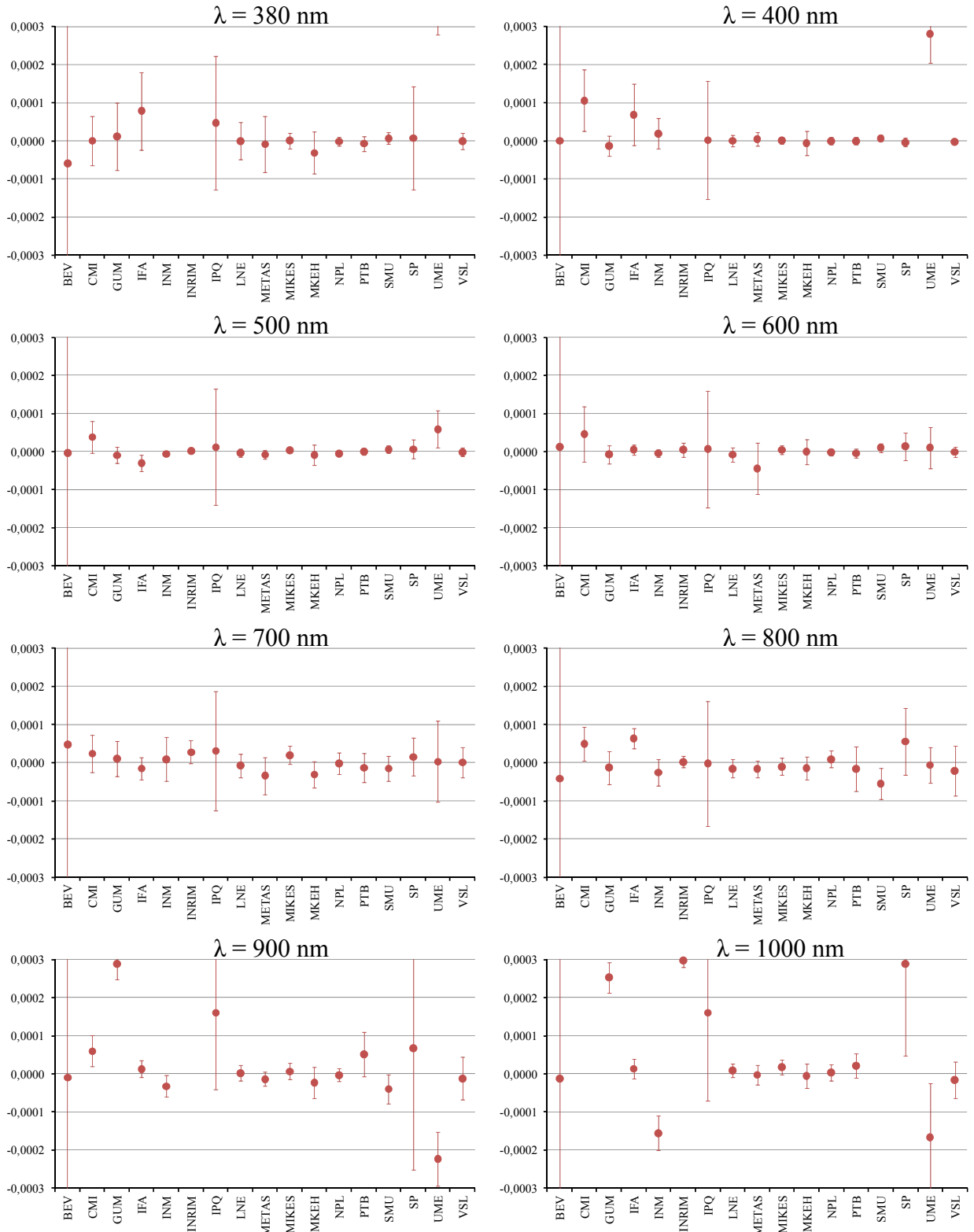

Figure 18 – DoE between laboratories and the KCRV for filter E

7. Conclusion

The present Draft-B presents the degree of equivalence of the participants to the EURAMET-PR-K6 comparison based on the reference value of the CCPR-K6 comparison.

Annex A

EUROMET-PR-K6 Key Comparison

Spectral Regular Transmittance

Technical Protocol

1. Introduction

- 1.1 The metrological equivalence of national measurement standards will be determined by a set of key comparisons chosen and organised by the Consultative Committees of the CIPM working closely with the Regional Metrology Organisations (RMOs).
- 1.2 In order to link to the CIPM key comparisons the laboratories which are not participating in the key comparison organised by the Consultative Committee of the CIPM it has been decided to organise the same comparisons within the Regional Metrology Organisations. These comparisons have to include at least two laboratories which have taken part in the same CIPM key comparisons.
- 1.3 At its meeting in March 1997, the Consultative Committee for Photometry and radiometry, CCPR, identified several key comparisons in the field of optical radiation metrology. In particular, it decided that a key comparison of spectral regular transmittance shall be carried out, with the BNM-INM (France) acting as pilot laboratory.
- 1.4 The EUROMET project 538 “ Comparison of spectral regular transmittance” in charge of doing the link between the European laboratories and the CCPR key comparison has been started in April 1999 with the BNM-INM (France) acting as pilot laboratory. It was decided to use exactly the same technical protocol as for the CCPR key comparison.
- 1.5 This technical protocol has been drawn up by a small working group comprising the Institut National de Metrologie, France (BNM-INM), the Helsinki University of Technology, Finland (HUT), the Measurement Standard Laboratory, New Zealand (MSL), the National Institute of Standard and Technology, USA (NIST), the National Physical Laboratory, UK (NPL), and the Physikalisch-Technische Bundesanstalt, Germany (PTB).
- 1.6 The procedures outlined in this document cover the technical procedure to be followed during measurement of the transfer standard filters. The procedure, which followed the guidelines established by the BIPM³, is based on current best practise in the use of standard filters and takes account of the experience gained from the previous comparisons organised in this field⁴.

³ T.J. Quinn, « Guidelines for key comparison carried out by Consultative Committees », BIPM, Paris, 1 March 1999

⁴ K.L. Eckerle, J. Bastie, J. Zwinkels, V. Sapritsky, A. Ulyanov, « Comparison of regular transmittance scales of four national standardizing laboratories », Color research and application, volume 18, number 1, February 1993.

J.F. Verrill, « Intercomparison of spectrophotometric measurements of regular transmittance », Report contract N°. MAT1-CT940021, November 1996.

Etc.....

1.7 At the EUROMET Contact Person meeting in April 2000, in Istanbul it was decided to have the link between the CCPR K6 comparison and the EUROMET K6 comparison using the results of all the European laboratories which have taken part to the CCPR K6 comparison but without new measurements. This is possible because the comparison are running approximately at the same time and with the same pilot laboratory.

Organisation

1.1 Participants

- 1.1.1 The list of participants was drafted by the pilot laboratory starting from the present list of EUROMET member and observer laboratories, and the answers to the proposal of the EUROMET project 538.
- 1.1.2 All participants must be able to demonstrate independent traceability to the realisation of the quantity, or make clear the route of traceability to the quantity via another named laboratory.
- 1.1.3 By their declared intention to participate in this key comparison, the laboratories accept the general instructions and the technical protocols written down in this document and commit themselves to follow the procedures strictly.
- 1.1.4 Once the protocol and list of participants has been agreed, no change to the protocol or list of participants may be made without prior agreement of all participants.

1.2 Participants' details

BEV	Dr Michael Matus Bundesamt für Eich- und Vermessungswesen Gruppe Eichwesen Arltgasse 35 1160 Wien Austria	Phone : +43 1 49 110 540 Fax : +43 1 49 20 875 E-mail : m.matus@bev-eich.gv.at
BNM- INM	Dr Jean Bastie BNM-INM/CNAM 292 rue Saint Martin 75003 Paris France	Phone : 33 1 40 27 20 25 Fax : 33 1 42 71 37 36 E-mail : bastie@cnam.fr

CETO	Prof Olivério Soares Centro de Ciências e Tecnologias Ópticas Faculdade de Ciências da Universidade do Porto Rua do Campo Alegre, 687 4150-007 Porto Portugal	Phone : +351 22 608 26 26 Fax : +351 22 608 26 28 E-mail : ceto@fc.up.pt
CMI	Dr Marek Smid Czech Metrology Institute Laboratory of Fundamental Metrology V botanic 4 150 72 Praha 5 Czech Republic	Phone : +420 2 5731 98 30 Fax : +420 2 5732 80 77 E-mail : msmid@cmi.cz
GUM	Mr J Pietrzykowski Central Office of Measures Główny Urząd Miar 00-950 Warszawa P.O. Box 10 ul. Elektoralna 2 Poland	Phone : +48 22 620 59 71 Fax : +48 22 620 83 78 Radiation@gum.gov.pl
HUT	Dr Farshid Manoocheri HUT - Metrology Research Institute Otakaari 5 A PO Box 3000 FIN-02015 HUT Finland	Phone : + 358 9 451 2337 Fax : + 358 9 451 2222 E-mail : farshid.manoocheri@hut.fi
IEN	Dr Maria Luisa Rastello IEN Strada delle Cacce, 91 10135 Torino Italy	Phone : + 39 11 3919 219 Fax : + 39 11 34 63 84 E-mail : rastello@ft.ien.it
IFA	Dr Alicia Pons CSIC - Instituto de Física Aplicada C/Serrano 144 28006 Madrid Spain	Phone : + 34 91 561 8806 Fax : + 34 91 411 7651 E-mail : apons@fresno.csic.es
INM	Dr Mihai Simionescu Institutul National de Metrologie Sos. Vitan –Bârzesti 11 Sector 4 Bucuresti 042122 Roumanie	Phone : +40-1-334 50 60 Fax : +40-1-334 53 45 E-mail : mihai.simionescu@inm.ro
METAS	Dr Peter Blattner Swiss Federal Office of Metrology Lindenweg 50 3003 Bern-Wabern Switzerland	Phone : +41 31 32 33 340 Fax : +41 31 32 33 210 E-mail : peter.blattner@ofmet.admin.ch

NPL	Dr Julie Taylor National Physical Laboratory Queens Road Teddington Middlesex TW11 0LW United Kingdom	Phone : + 44 81 943 6539 Fax : + 44 81 943 6283 E-mail : Julie.taylor@npl.co.uk
OMH	Dr Gyula Dézsi National Office of Measures, Optical section Németrölgyi ut 37 – 39 Budapest H – 1124 Hungary	Phone : + 36 1 45 85 833 Fax : + 36 1 214 3157 E-mail : gdezsi@omh.hu
PTB	Dr Alfred Schirmacher PTB – Laboratorium für Bildoptik und Spektrometrie 4.21S Bundesallee 100 D – 38116 Braunschweig Germany	Phone : + 49 531 592 4231 Fax : + 49 531 592 4272 or 9292 E-mail : alfred.schirmacher@ptb.de
SMU	Dr Peter Nemecek SMU – Laboratory for thermometry and optical radiometry Karloveska 63 842 55 Bratislava Slovakia	Phone : + 421 7 602 94 278 Fax : + 421 7 654 29 592 E-mail : nemecek@smu.savba.sk
SP	Dr Anne Andersson-Fäldt Swedish National Testing and Research Institute P.O. Box 857 501 15 Boras Sweden	Phone : +46 33 16 54 03 Fax : +46 33 16 56 20 E-mail : anne.afaldt@sp.se
UME	Dr Kamuran Turkoglu Ulusal Metroloji Enstitüsü TUBITAK-UME PO Box 54 41470 Gebze, Kocaeli Turkey	Phone : + 90 262 679 5000, ext : 3353 Fax : + 90 262 679 5001 E-mail : akt@ ume.tubitak.gov.tr

The laboratories in grey cells are the laboratories which have taken part in the CCPR K6 comparison and which are doing the link between both comparisons.

1.3 Form of comparison

- 1.3.1 The comparison will principally be carried out through the calibration group of transfer standard filters. Each participant will use a separate set of filters to minimise the time needed for the completion of the comparison.
- 1.3.2 A full description of the transfer standard filters is given in section 3 of this protocol.
- 1.3.3 The comparison will take the form of a star comparison, carried out in one single phase. The artefacts (filters) will initially be calibrated by the pilot laboratory. They will then

distributed to participants who will perform the calibration. They will be returned to the pilot laboratory to carry out a repeat calibration to check the stability.

1.3.4 BNM-INM will act as the pilot laboratory. All results are to be communicated directly to the pilot laboratory as soon as possible and certainly within 6 weeks of completion of the measurements by a laboratory.

1.3.5 Each laboratory has 3 months for calibration and transportation. With its confirmation to participate, each laboratory has confirmed that it is capable to perform the measurements in the time allocated to it.

1.3.6 If for some reasons, the measurement facility is not ready or customs clearance takes too much time in a country, the participant laboratory must contact the pilot laboratory immediately. It may possible for the participant to continue to take part by returning the calibrated filters back to the pilot laboratory at an agreed later date. However, in view of the large amount of work for the pilot laboratory this may not be possible. If this the case the participant and their results may have to be excluded from the final report. Exclusion may also occur if the results are not available in time to prepare the draft report.

1.3.7 Revised Timetable

Activity	Date
-----------------	-------------

Invitation to participate (start of the EUROMET project 548)	April 1999
Participants received filters	February 2001
Filters returned to BNM	May 2001
Draft A comparison report circulated	December 2001
Draft B comparison report submitted to EUROMET	April 2002

1.4 Handling the artefacts

1.4.1 The standard filters should be examined immediately upon receipt at final destination. The condition of the filters and associated packaging should be noted and communicated to the pilot laboratory. Please use the fax form or e-mail form in appendix A4 and A5.

1.4.2 The standard filters should only be handled by authorised persons and stored in such a way as to prevent damage.

1.4.3 No cleaning of any filter should be normally done. Dust could be removed with a very soft brush or with a stream of dry nitrogen or dry CO₂. In case of accidental pollution cleaning will be made with alcohol and special optical paper. Cleaning must be indicated in the measurement report and documented using the appropriate form in appendix A.2. If a filter appears damaged, a replacement will be available from the pilot laboratory.

1.4.4 After the measurements, the filters should be repackaged in their original transit cases or any other appropriate case for transportation. Ensure that the content of the package is complete before shipment. A copy of the provisional results should be included in the package.

1.5 Transport of artefacts

- 1.5.1 It is of outmost importance that the artefacts be transported in a manner in which they will not be lost, damaged or handled by unauthorised persons.
- 1.5.2 Artefact should be marked as “fragile”.
- 1.5.3 The artefacts should be accompanied by a suitable customs carnet (where appropriate) or documentation identifying the items uniquely.
- 1.5.4 Transportation is each laboratory’s responsibility and cost. Each participating laboratory covers the costs for its own measurements, transportation and any customs charges as well as for any damages that may have occurred within its country. The overall costs for the organisation of the comparison are covered by the pilot laboratory. The pilot laboratory has no insurance for any loss or damage of the standards during transportation.

2. Description of the standards

2.1 The filter set to check the photometric scale is comprised of 5 neutral coloured glass filter plates 50 mm x 50 mm with nominal transmittance, at the wavelength of 546 nm, of approximately 92%, 56%, 10%, 1% and 0.1%. The filters are contained in a wooden box specially design for transportation.

2.2 Each filter is identified by a reference engraved in a corner outside the area used for measurement. This reference has two parts. One is a letter indicating the type of glass (see table below) the other is the serial number of the filter.

2.3 The main characteristics of the filters are summarised in the following table:

Nominal transmittance %	Type of glass	Nominal thickness mm	Reference
92	BK 7	4.0	A
56	NG 11	1.5	B
10	NG 5	3.9	C
1	NG 4	3.9	D
0.1	NG 3	3.1	E

2.4 The manufacturing tolerances are for :

Size : 50 x50 (+0/-0.3) mm

Flatness : better than 5 µm over a central diameter of 30 mm

Parallelism : better than 0.02 mm except for the filter of transmittance 92% (<0.1 mm)

3. Measurement instructions

3.1 Traceability

Temperature measurements should be made using the International Temperature Scale of 1990 (ITS-90)

3.2 Measurand

3.2.1 The measurand is the spectral transmittance of the filters. The measurement should be performed in suitable laboratory accommodation maintained at a temperature of $23 \pm 2^\circ\text{C}$. The exact temperature of the laboratory during the time of the measurements should be reported.

3.2.2 The filter transmittance has to be measured independently several times. The exact number of measurements should be that normally used by the participating laboratory to obtain the appropriate accuracy of their specific measurement facility. The exact number of measurements used should be stated in the measurement report but only the mean or final declared value of the set is to be reported in the Table of measurement results.

3.3 Measurement instructions

3.3.1 Before measurement each filter should be inspected for damage or contamination. Any damage or cleaning should be documented using the appropriate form in appendix A5.

3.3.2 The spectral transmittance measurement of the filters should be performed at the following wavelengths : 380, 400, 500, 600, 700, 800, 900 and 1000 nm.

3.3.3 The beam geometry must be a parallel beam where possible. For instruments that do not use a parallel beam the departure from parallel should be stated. The beam size probably will be different for the different instruments. 20mm diameter or 20mm square might be considered an ideal compromise between the conflicting requirements of flux and uniformity.

3.3.4 The angle of incidence on the filter should be normal or near normal and should be stated in the report.

3.3.5 The bandwidth used for the measurement should be stated in the report. 1 nm might be considered the norm for this wavelength range. However, there is no need for an agreed value of bandwidth because of the spectral neutrality of the filters.

3.3.6 Any information obtained relating to the use or any results obtained by a participant during the course of the comparison shall be sent only to the pilot laboratory who will be responsible for co-ordinating how the information should be disseminated to other participants. No communication whatsoever regarding any details of the comparison other than the general conditions described in this protocol shall occur between any of the participants or any party external to the comparison without the written consent of the pilot laboratory. The pilot laboratory will in turn seek permission of all the participants. This is to ensure that no bias from whatever accidental means can occur.

4. Measurement uncertainty

4.1 Measurement uncertainty shall be estimated according to the ISO Guide to the expression of uncertainty in measurement. In order to achieve optimum comparability, a list containing the principal influence parameters for calibration of spectral transmittance is given below. An example table which should be completed by participants is included as appendix A3. The participating laboratories are encouraged to follow this breakdown as closely as possible, and to adapt it to their instruments and procedures. Additional uncertainty parameters may be included dependent on the specific measurement facilities and these should be annotated with an appropriate explanation and/or reference. As well as the value associated with the uncertainty, participants should give an indication as to the basis of their estimate. All values should be given for a coverage factor of $k=1$.

4.2 Type A

4.2.1 Repeatability of measurements.

The repeatability of measurements can be determined in calculating the standard deviation of a set of measurements without realignment or repositioning of the filter. It characterises mainly the noise and the stability of the experimental set-up.

4.2.2 Reproducibility of measurements.

The reproducibility of measurements can be determined in calculating the standard deviation of a set of measurement with realignment and repositioning of the filter between each individual measurement. It characterise the whole process of the measurement. It is this value which has to be taken into account for the uncertainty evaluated according the type A method.

4.3 Type B

4.3.1 Main uncertainty components.

The 3 main components of uncertainty usually determined by type B method are :

- The non linearity of the detector over the dynamic range of the detector used for the measurements
- The uncertainty of the wavelength setting of the monochromator
- The stray light.

The uncertainties related to these effects have to be clearly stated in the uncertainty budget provided with the results of the comparison.

4.3.2 Other uncertainty components.

The other uncertainty components which can be put in the uncertainty budget if necessary are :

- The beam displacement effect and the defocusing effect due to introduction of the filter in the beam.
- The inter-reflection between the filter and the various optical and mechanical components of the experimental set-up.
- The obliquity effect due to the residual non parallelism of the beam, a non parallel beam or the imperfect alignment of the filter.
- The effect of the polarisation of the light
- The drift of the detector and/or of the sources during the measurements.

- Any other uncertainty components specific to the apparatus used for the measurements as explained in § 5.1.

5. Reporting of results

- 5.1 On completion of the measurements by the participating laboratory the provisional results of these measurements should be sent to the pilot laboratory with the filters.
- 5.2 The Final results should be communicated to the pilot laboratory at the latest within six weeks.
- 5.3 In completing the description of the participants measurement facility, appendix A.2, it would be useful for a schematic diagram of the facility to be included.
- 5.4 The measurement report forms in appendix A.1, A.2, A.3 of this document will be sent by e-mail to all participating laboratories. It would be appreciated if the report form (in particular the results sheet) could be completed by computer and sent back electronically to the coordinator. **In any case, the signed report must also be sent in paper form by mail.** In of any differences, the paper forms are considered to be the definitive version.
- 5.5 Following receipt of all measurement reports from the participating laboratories, the pilot laboratory will analyse the results and prepare a first draft report on the comparison. This will be circulated to the participants for comments, additions and corrections. Subsequently, the procedure outlined in the BIPM and EUROMET Guidelines will be followed.

A.1 Measurement results

The attached measurement summary should be completed for each filter. For clarity and consistency the following list describes what should be entered under the appropriate heading in the table.

Wavelength	The assigned centre wavelength of the measured spectral transmittance.
Spectral transmittance	The value of the spectral transmittance of the filter as measured by the participating laboratory.
Bandwidth	The spectral bandwidth of the instrument used for the measurement defined as the Full Width at Half the Maximum.
Standard Deviation	The standard deviation of the number of measurements made to obtain the assigned transmittance of the filter.
Number of runs	The number of independent measurements made to obtain the specified standard deviation.
Uncertainty	The total uncertainty of the measurement of spectral transmittance including both Type A and B for a coverage factor of $k=1$.

Table of measurement results

Reference of the filter :

Ambient temperature :

Wavelength nm	Spectral transmittance	Bandwidth nm	Standard deviation	Number of runs	Uncertainty
380					
400					
500					
600					
700					
800					
900					
1000					

Laboratory :

Date :

Signature :

A.2 Description of the measurement facility.

This form should be used as a guide. It is anticipated that many of the questions will require more information than the space allocated, please use separate sheets of paper as appropriate.

Make and type of the spectrophotometer

.....
.....
.....
.....

Method of characterisation of the spectrophotometer

.....
.....
.....
.....
.....
.....
.....

Description of measuring technique (please include a diagram if appropriate)

.....
.....
.....
.....
.....

Description of calibration laboratory conditions : e.g. temperature, humidity, cleaning of the filter if it has be done due to accidental pollution etc

.....
.....
.....

Laboratory :

Date :

Signature :

A.3 Uncertainty of measurement

Parameter	Type A	Type B	Uncertainty in spectral transmittance
Repeatability	U ₁		
Non linearity		U ₂	
Wavelength setting		U ₃	
Beam displacement		U ₄	
Inter-reflection		U ₅	
Obliquity effect		U ₆	
Polarisation		U ₇	
Drift		U ₈	
Others		U ₉	
RMS total			

The table is a suggested layout for the presentation of uncertainties for the calibration of each filter. However, it should be noted that since the uncertainties are wavelength dependant this table can only present a range for the various parameters. The summary table associated with the results (appendix A.1.) will of course take account of the wavelength dependent parameters. The RMS total refers to the usual expression i.e. square root of the sum of the squares of all the individual uncertainty terms.

Laboratory :

Date :

Signature :

A.4 Receipt confirmation

To : Jean Bastie
BNM-INM / CNAM
292 rue Saint Martin
75003 Paris
France

Fax : + 33 1 42 71 37 36
E-mail : bastie@cnam.fr

From : (participating laboratory)

We confirmed having received the standards of the BIPM Key comparison “regular spectral transmittance”.

Date :

Signature :

A.5 Inspection of the transfer standards

Has the filter transportation package been opened during transit ? e.g; Customs.....Y / N

If yes please give details.....

Is there any damage to the transportation package ?.....Y / N

If yes please give details.....

Are there any visible signs of damage to the filters ?.....Y / N

If yes please give details.....

Laboratory :

Date :

Signature :

ANNEX B

Pilot laboratory transmittance measurements $\tau_{X_i, r}^P$ for $r = 1$ (measurement before dispatching)

Wavelength	BEV	CMI	GUM	IFA	INM	INRIM	IPQ	METAS	MIKES	MKEH	NPL	PTB	SMU	SP	UME	VSL	
Filter A	380	9,108E-1	9,128E-1	9,112E-1	9,110E-1	9,078E-1	9,096E-1	9,072E-1	9,123E-1	9,122E-1	9,118E-1	9,118E-1	9,086E-1	9,070E-1	9,125E-1	9,025E-1	9,121E-1
λ (nm)	400	9,116E-1	9,147E-1	9,127E-1	9,128E-1	9,095E-1	9,114E-1	9,082E-1	9,140E-1	9,139E-1	9,129E-1	9,135E-1	9,104E-1	9,084E-1	9,138E-1	9,040E-1	9,137E-1
	500	9,143E-1	9,175E-1	9,154E-1	9,160E-1	9,114E-1	9,132E-1	9,107E-1	9,164E-1	9,168E-1	9,156E-1	9,166E-1	9,142E-1	9,116E-1	9,166E-1	9,064E-1	9,169E-1
	600	9,164E-1	9,184E-1	9,165E-1	9,177E-1	9,143E-1	9,162E-1	9,136E-1	9,178E-1	9,181E-1	9,173E-1	9,177E-1	9,165E-1	9,137E-1	9,179E-1	9,089E-1	9,181E-1
	700	9,159E-1	9,192E-1	9,177E-1	9,184E-1	9,149E-1	9,174E-1	9,147E-1	9,186E-1	9,190E-1	9,183E-1	9,186E-1	9,172E-1	9,162E-1	9,197E-1	9,124E-1	9,189E-1
	800	9,154E-1	9,195E-1	9,185E-1	9,189E-1	9,159E-1	9,186E-1	9,155E-1	9,191E-1	9,193E-1	9,194E-1	9,192E-1	9,182E-1	9,180E-1	9,209E-1	9,180E-1	9,192E-1
	900	9,155E-1	9,205E-1	9,189E-1	9,194E-1	9,145E-1	9,191E-1	9,158E-1	9,200E-1	9,201E-1	9,192E-1	9,198E-1	9,189E-1	9,185E-1	9,216E-1	9,183E-1	9,197E-1
	1000	9,161E-1	9,204E-1	9,193E-1	9,198E-1	9,162E-1	9,195E-1	9,160E-1	9,199E-1	9,206E-1	9,198E-1	9,203E-1	9,187E-1	9,188E-1	9,217E-1	9,187E-1	9,199E-1
Filter B	380	4,072E-1	4,042E-1	4,068E-1	4,055E-1	4,117E-1	4,030E-1	4,049E-1	4,072E-1	4,040E-1	4,069E-1	4,037E-1	4,040E-1	4,047E-1	4,103E-1	3,990E-1	4,064E-1
λ (nm)	400	6,048E-1	6,033E-1	6,057E-1	6,043E-1	6,099E-1	6,038E-1	6,047E-1	6,062E-1	6,022E-1	6,055E-1	6,029E-1	6,030E-1	6,038E-1	6,070E-1	5,991E-1	6,048E-1
	500	6,192E-1	6,172E-1	6,200E-1	6,186E-1	6,241E-1	6,176E-1	6,185E-1	6,202E-1	6,168E-1	6,198E-1	6,174E-1	6,174E-1	6,185E-1	6,214E-1	6,135E-1	6,197E-1
	600	6,077E-1	6,057E-1	6,084E-1	6,074E-1	6,129E-1	6,057E-1	6,068E-1	6,083E-1	6,056E-1	6,080E-1	6,062E-1	6,061E-1	6,074E-1	6,101E-1	6,022E-1	6,082E-1
	700	6,352E-1	6,351E-1	6,365E-1	6,361E-1	6,406E-1	6,342E-1	6,349E-1	6,366E-1	6,339E-1	6,369E-1	6,348E-1	6,347E-1	6,358E-1	6,380E-1	6,313E-1	6,365E-1
	800	5,749E-1	5,754E-1	5,765E-1	5,760E-1	5,807E-1	5,736E-1	5,743E-1	5,763E-1	5,740E-1	5,770E-1	5,745E-1	5,743E-1	5,756E-1	5,788E-1	5,704E-1	5,761E-1
	900	5,003E-1	5,006E-1	5,016E-1	5,013E-1	5,064E-1	4,985E-1	4,996E-1	5,019E-1	4,995E-1	5,023E-1	4,998E-1	4,994E-1	5,009E-1	5,041E-1	4,952E-1	5,018E-1
	1000	4,524E-1	4,520E-1	4,535E-1	4,533E-1	4,581E-1	4,503E-1	4,512E-1	4,536E-1	4,516E-1	4,539E-1	4,516E-1	4,512E-1	4,528E-1	4,564E-1	4,468E-1	4,538E-1
Filter C	380	2,094E-2	2,089E-2	2,064E-2	2,198E-2	2,062E-2	2,098E-2	2,052E-2	2,144E-2	2,077E-2	2,092E-2	2,130E-2	2,103E-2	2,076E-2	2,105E-2	2,101E-2	2,184E-2
λ (nm)	400	9,401E-2	9,384E-2	9,311E-2	9,690E-2	9,255E-2	9,408E-2	9,267E-2	9,578E-2	9,352E-2	9,373E-2	9,502E-2	9,446E-2	9,349E-2	9,407E-2	9,429E-2	9,657E-2
	500	9,067E-2	9,045E-2	9,000E-2	9,328E-2	8,931E-2	9,071E-2	8,932E-2	9,199E-2	9,021E-2	9,061E-2	9,148E-2	9,086E-2	9,030E-2	9,090E-2	9,100E-2	9,299E-2
	600	7,595E-2	7,576E-2	7,528E-2	7,814E-2	7,486E-2	7,594E-2	7,479E-2	7,673E-2	7,553E-2	7,594E-2	7,658E-2	7,600E-2	7,562E-2	7,619E-2	7,620E-2	7,786E-2
	700	1,596E-1	1,594E-1	1,584E-1	1,631E-1	1,575E-1	1,600E-1	1,579E-1	1,611E-1	1,591E-1	1,594E-1	1,607E-1	1,599E-1	1,591E-1	1,599E-1	1,603E-1	1,625E-1
	800	1,487E-1	1,484E-1	1,475E-1	1,519E-1	1,460E-1	1,488E-1	1,471E-1	1,498E-1	1,481E-1	1,482E-1	1,496E-1	1,488E-1	1,480E-1	1,490E-1	1,492E-1	1,513E-1
	900	1,016E-1	1,015E-1	1,007E-1	1,044E-1	9,961E-2	1,020E-1	1,003E-1	1,027E-1	1,013E-1	1,014E-1	1,025E-1	1,018E-1	1,013E-1	1,019E-1	1,022E-1	1,039E-1
	1000	7,567E-2	7,551E-2	7,489E-2	7,789E-2	7,397E-2	7,588E-2	7,464E-2	7,631E-2	7,533E-2	7,545E-2	7,636E-2	7,576E-2	7,537E-2	7,588E-2	7,613E-2	7,752E-2
Filter D	380	3,097E-4	2,864E-4	3,079E-4	3,520E-4	2,974E-4	3,471E-4	3,675E-4	3,686E-4	3,579E-4	3,899E-4	3,936E-4	3,849E-4	3,558E-4	3,555E-4	3,847E-4	3,617E-4
λ (nm)	400	5,160E-3	5,072E-3	5,111E-3	5,096E-3	5,114E-3	4,930E-3	5,137E-3	5,156E-3	5,122E-3	5,473E-3	5,321E-3	5,360E-3	5,126E-3	5,091E-3	5,443E-3	5,125E-3
	500	8,410E-3	8,320E-3	8,331E-3	8,288E-3	8,317E-3	8,071E-3	8,387E-3	8,363E-3	8,347E-3	8,898E-3	8,627E-3	8,682E-3	8,352E-3	8,319E-3	8,795E-3	8,359E-3
	600	8,318E-3	8,225E-3	8,243E-3	8,203E-3	8,240E-3	7,987E-3	8,292E-3	8,288E-3	8,245E-3	8,807E-3	8,509E-3	8,567E-3	8,255E-3	8,242E-3	8,698E-3	8,252E-3
	700	2,643E-2	2,617E-2	2,631E-2	2,621E-2	2,615E-2	2,568E-2	2,639E-2	2,641E-2	2,629E-2	2,761E-2	2,697E-2	2,708E-2	2,635E-2	2,629E-2	2,742E-2	2,634E-2
	800	3,204E-2	3,175E-2	3,205E-2	3,188E-2	3,180E-2	3,128E-2	3,207E-2	3,216E-2	3,201E-2	3,354E-2	3,275E-2	3,292E-2	3,206E-2	3,200E-2	3,327E-2	3,198E-2
	900	2,245E-2	2,221E-2	2,242E-2	2,230E-2	2,223E-2	2,183E-2	2,242E-2	2,248E-2	2,239E-2	2,357E-2	2,296E-2	2,310E-2	2,243E-2	2,237E-2	2,337E-2	2,246E-2
	1000	1,660E-2	1,642E-2	1,659E-2	1,651E-2	1,647E-2	1,614E-2	1,661E-2	1,665E-2	1,659E-2	1,752E-2	1,705E-2	1,715E-2	1,662E-2	1,654E-2	1,736E-2	1,665E-2
Filter E	380	3,624E-5	5,566E-5	-1,491E-5	1,650E-5	9,445E-5	1,901E-5	-8,704E-5	4,512E-5	1,542E-5	5,726E-5	1,189E-5	1,955E-5	1,138E-5	-9,172E-6	8,311E-6	1,238E-5
λ (nm)	400	3,456E-4	3,194E-4	3,699E-4	3,317E-4	3,677E-4	3,488E-4	3,290E-4	3,128E-4	3,451E-4	3,428E-4	2,928E-4	3,207E-4	2,877E-4	3,525E-4	3,139E-4	3,059E-4
	500	9,156E-4	8,827E-4	9,793E-4	9,279E-4	9,964E-4	9,605E-4	8,547E-4	8,734E-4	9,495E-4	9,233E-4	8,301E-4	8,962E-4	8,145E-4	9,534E-4	8,810E-4	8,566E-4
	600	9,802E-4	9,492E-4	1,043E-3	9,866E-4	1,056E-3	1,026E-3	9,226E-4	9,406E-4	1,014E-3	1,000E-3	8,879E-4	9,581E-4	8,707E-4	1,025E-3	9,453E-4	9,243E-4
	700	4,949E-3	4,822E-3	5,190E-3	5,005E-3	5,281E-3	5,144E-3	4,715E-3	4,793E-3	5,111E-3	5,033E-3	4,631E-3	4,866E-3	4,554E-3	5,099E-3	4,815E-3	4,749E-3
	800	9,530E-3	9,312E-3	9,919E-3	9,621E-3	1,007E-2	9,867E-3	9,118E-3	9,255E-3	9,803E-3	9,640E-3	8,966E-3	9,402E-3	8,862E-3	9,757E-3	9,311E-3	9,193E-3
	900	8,317E-3	8,097E-3	8,657E-3	8,392E-3	8,788E-3	8,614E-3	7,925E-3	8,064E-3	8,554E-3	8,441E-3	7,809E-3	8,194E-3	7,713E-3	8,503E-3	8,116E-3	8,005E-3
	1000	7,023E-3	6,838E-3	7,320E-3	7,101E-3	7,440E-3	7,290E-3	6,691E-3	6,802E-3	7,234E-3	7,102E-3	6,573E-3	6,922E-3	6,496E-3	7,194E-3	6,854E-3	6,755E-3

Pilot laboratory transmittance measurements $\tau_{X_i, r}^P$ for $r = 2$ (measurement after return to pilot laboratory)

Wavelength	BEV	CMI	GUM	IFA	INM	INRIM	IPQ	METAS	MIKES	MKEH	NPL	PTB	SMU	SP	UME	VSL	
Filter A	380	9,117E-1	9,108E-1	9,110E-1	9,104E-1	9,125E-1	9,099E-1	8,965E-1	9,122E-1	9,128E-1	9,100E-1	9,122E-1	9,129E-1	9,069E-1	9,135E-1	8,979E-1	9,133E-1
λ (nm)	400	9,133E-1	9,134E-1	9,125E-1	9,121E-1	9,122E-1	9,101E-1	8,990E-1	9,120E-1	9,147E-1	9,105E-1	9,140E-1	9,145E-1	9,087E-1	9,140E-1	8,995E-1	9,153E-1
	500	9,156E-1	9,159E-1	9,150E-1	9,150E-1	9,150E-1	9,123E-1	9,031E-1	9,157E-1	9,172E-1	9,128E-1	9,166E-1	9,171E-1	9,116E-1	9,163E-1	9,005E-1	9,176E-1
	600	9,184E-1	9,157E-1	9,162E-1	9,165E-1	9,172E-1	9,158E-1	9,128E-1	9,165E-1	9,187E-1	9,170E-1	9,181E-1	9,187E-1	9,135E-1	9,188E-1	9,059E-1	9,192E-1
	700	9,199E-1	9,168E-1	9,165E-1	9,176E-1	9,177E-1	9,177E-1	9,164E-1	9,179E-1	9,197E-1	9,184E-1	9,188E-1	9,192E-1	9,147E-1	9,198E-1	9,127E-1	9,196E-1
	800	9,199E-1	9,188E-1	9,183E-1	9,187E-1	9,191E-1	9,186E-1	9,179E-1	9,192E-1	9,203E-1	9,191E-1	9,191E-1	9,198E-1	9,143E-1	9,199E-1	9,173E-1	9,204E-1
	900	9,203E-1	9,193E-1	9,187E-1	9,190E-1	9,190E-1	9,186E-1	9,196E-1	9,206E-1	9,196E-1	9,195E-1	9,199E-1	9,144E-1	9,203E-1	9,178E-1	9,208E-1	
	1000	9,206E-1	9,195E-1	9,190E-1	9,194E-1	9,198E-1	9,194E-1	9,188E-1	9,199E-1	9,210E-1	9,199E-1	9,200E-1	9,203E-1	9,149E-1	9,207E-1	9,181E-1	9,211E-1
Filter B	380	4,067E-1	4,043E-1	4,077E-1	4,077E-1	4,135E-1	4,047E-1	4,068E-1	4,060E-1	4,044E-1	4,084E-1	4,044E-1	4,054E-1	4,066E-1	4,125E-1	3,988E-1	4,067E-1
λ (nm)	400	6,031E-1	6,031E-1	6,067E-1	6,069E-1	6,121E-1	6,053E-1	6,071E-1	6,064E-1	6,023E-1	6,063E-1	6,035E-1	6,053E-1	6,065E-1	6,081E-1	5,968E-1	6,059E-1
	500	6,182E-1	6,182E-1	6,210E-1	6,211E-1	6,232E-1	6,198E-1	6,216E-1	6,215E-1	6,174E-1	6,214E-1	6,186E-1	6,197E-1	6,203E-1	6,233E-1	6,130E-1	6,204E-1
	600	6,073E-1	6,066E-1	6,087E-1	6,090E-1	6,130E-1	6,074E-1	6,084E-1	6,091E-1	6,055E-1	6,092E-1	6,058E-1	6,073E-1	6,083E-1	6,127E-1	6,011E-1	6,084E-1
	700	6,365E-1	6,356E-1	6,366E-1	6,369E-1	6,409E-1	6,357E-1	6,355E-1	6,369E-1	6,337E-1	6,368E-1	6,353E-1	6,355E-1	6,360E-1	6,400E-1	6,312E-1	6,367E-1
	800	5,771E-1	5,750E-1	5,774E-1	5,766E-1	5,805E-1	5,750E-1	5,746E-1	5,771E-1	5,735E-1	5,767E-1	5,753E-1	5,747E-1	5,754E-1	5,796E-1	5,721E-1	5,765E-1
	900	5,019E-1	4,994E-1	5,022E-1	5,015E-1	5,055E-1	4,993E-1	4,995E-1	5,019E-1	4,988E-1	5,015E-1	5,002E-1	4,993E-1	5,004E-1	5,047E-1	4,960E-1	5,017E-1
	1000	4,533E-1	4,508E-1	4,537E-1	4,532E-1	4,543E-1	4,506E-1	4,509E-1	4,535E-1	4,505E-1	4,530E-1	4,517E-1	4,509E-1	4,521E-1	4,563E-1	4,470E-1	4,535E-1
Filter C	380	2,097E-2	2,089E-2	2,084E-2	2,198E-2	2,108E-2	2,141E-2	2,061E-2	2,122E-2	2,079E-2	2,089E-2	2,124E-2	2,114E-2	2,083E-2	2,121E-2	2,133E-2	2,183E-2
λ (nm)	400	9,403E-2	9,397E-2	9,371E-2	9,711E-2	9,132E-2	9,466E-2	9,250E-2	9,574E-2	9,368E-2	9,287E-2	9,500E-2	9,507E-2	9,372E-2	9,261E-2	9,461E-2	9,674E-2
	500	9,061E-2	9,048E-2	9,023E-2	9,373E-2	8,907E-2	9,125E-2	8,897E-2	9,218E-2	9,032E-2	8,985E-2	9,162E-2	9,144E-2	9,034E-2	9,110E-2	9,120E-2	9,328E-2
	600	7,583E-2	7,569E-2	7,545E-2	7,851E-2	7,449E-2	7,611E-2	7,497E-2	7,679E-2	7,539E-2	7,567E-2	7,663E-2	7,632E-2	7,548E-2	7,616E-2	7,621E-2	7,800E-2
	700	1,596E-1	1,595E-1	1,590E-1	1,636E-1	1,568E-1	1,601E-1	1,583E-1	1,615E-1	1,590E-1	1,593E-1	1,608E-1	1,604E-1	1,590E-1	1,601E-1	1,602E-1	1,628E-1
	800	1,488E-1	1,484E-1	1,479E-1	1,523E-1	1,472E-1	1,491E-1	1,474E-1	1,505E-1	1,482E-1	1,484E-1	1,498E-1	1,493E-1	1,481E-1	1,491E-1	1,492E-1	1,516E-1
	900	1,018E-1	1,015E-1	1,011E-1	1,045E-1	1,004E-1	1,021E-1	1,007E-1	1,030E-1	1,013E-1	1,015E-1	1,026E-1	1,020E-1	1,012E-1	1,020E-1	1,022E-1	1,033E-1
	1000	7,567E-2	7,542E-2	7,504E-2	7,795E-2	7,450E-2	7,589E-2	7,474E-2	7,661E-2	7,524E-2	7,543E-2	7,632E-2	7,577E-2	7,525E-2	7,588E-2	7,600E-2	7,701E-2
Filter D	380	2,831E-4	2,742E-4	3,552E-4	3,489E-4	2,633E-4	3,614E-4	3,483E-4	3,111E-4	3,593E-4	3,811E-4	3,927E-4	3,874E-4	3,567E-4	4,062E-4	3,722E-4	3,575E-4
λ (nm)	400	5,119E-3	5,070E-3	5,108E-3	5,126E-3	5,049E-3	4,946E-3	5,121E-3	5,123E-3	5,117E-3	5,437E-3	5,322E-3	5,361E-3	5,176E-3	5,126E-3	5,398E-3	5,148E-3
	500	8,384E-3	8,278E-3	8,369E-3	8,309E-3	8,272E-3	8,102E-3	8,410E-3	8,385E-3	8,342E-3	8,861E-3	8,635E-3	8,673E-3	8,383E-3	8,401E-3	8,800E-3	8,352E-3
	600	8,264E-3	8,221E-3	8,256E-3	8,195E-3	8,172E-3	8,006E-3	8,269E-3	8,237E-3	8,237E-3	8,628E-3	8,510E-3	8,564E-3	8,265E-3	8,292E-3	8,683E-3	8,233E-3
	700	2,640E-2	2,628E-2	2,627E-2	2,624E-2	2,626E-2	2,575E-2	2,638E-2	2,642E-2	2,629E-2	2,736E-2	2,697E-2	2,704E-2	2,637E-2	2,633E-2	2,735E-2	2,632E-2
	800	3,218E-2	3,197E-2	3,201E-2	3,190E-2	3,205E-2	3,125E-2	3,208E-2	3,213E-2	3,199E-2	3,351E-2	3,272E-2	3,284E-2	3,207E-2	3,196E-2	3,329E-2	3,201E-2
	900	2,250E-2	2,233E-2	2,237E-2	2,230E-2	2,242E-2	2,179E-2	2,242E-2	2,246E-2	2,237E-2	2,354E-2	2,293E-2	2,304E-2	2,244E-2	2,232E-2	2,336E-2	2,244E-2
	1000	1,665E-2	1,652E-2	1,655E-2	1,650E-2	1,659E-2	1,609E-2	1,659E-2	1,662E-2	1,656E-2	1,749E-2	1,700E-2	1,710E-2	1,661E-2	1,650E-2	1,734E-2	1,663E-2
Filter E	380	1,011E-4	8,800E-6	1,621E-5	2,461E-5	1,388E-5	1,321E-5	2,352E-5	1,328E-5	1,801E-5	2,444E-5	1,056E-5	1,663E-5	1,137E-5	2,072E-5	1,154E-5	1,118E-5
λ (nm)	400	2,938E-4	3,132E-4	3,502E-4	3,322E-4	3,074E-4	3,464E-4	2,853E-4	3,137E-4	3,476E-4	3,302E-4	2,928E-4	3,190E-4	2,884E-4	3,454E-4	3,088E-4	3,067E-4
	500	9,246E-4	8,868E-4	9,754E-4	9,259E-4	9,932E-4	9,657E-4	8,517E-4	8,867E-4	9,512E-4	9,483E-4	8,331E-4	8,959E-4	8,184E-4	9,482E-4	8,729E-4	8,721E-4
	600	9,799E-4	9,504E-4	1,042E-3	9,879E-4	1,065E-3	1,028E-3	8,963E-4	1,007E-3	1,014E-3	9,643E-4	8,886E-4	9,557E-4	8,709E-4	9,798E-4	9,291E-4	9,192E-4
	700	4,938E-3	4,830E-3	5,166E-3	5,009E-3	5,263E-3	5,149E-3	4,677E-3	4,847E-3	5,116E-3	5,014E-3	4,628E-3	4,864E-3	4,559E-3	5,075E-3	4,850E-3	4,749E-3
	800	9,522E-3	9,289E-3	9,912E-3	9,621E-3	1,004E-2	9,854E-3	9,115E-3	9,235E-3	9,795E-3	9,617E-3	8,951E-3	9,382E-3	8,862E-3	9,764E-3	9,293E-3	9,193E-3
	900	8,306E-3	8,098E-3	8,657E-3	8,387E-3	8,772E-3	8,605E-3	7,942E-3	8,054E-3	8,541E-3	8,388E-3	7,788E-3	8,172E-3	7,706E-3	8,526E-3	8,100E-3	8,002E-3
	1000	7,020E-3	6,835E-3	7,325E-3	7,090E-3	7,427E-3	7,279E-3	6,699E-3	6,796E-3	7,222E-3	7,088E-3	6,561E-3	6,901E-3	6,489E-3	7,208E-3	6,841E-3	6,747E-3

Wavelength	BEV	CMI	GUM	IFA	INM	INRIM	IPQ	METAS	MIKES	MKEH	NPL	PTB	SMU	SP	UME	VSL	
Filter A	380	9,112E-1	9,118E-1	9,111E-1	9,107E-1	9,102E-1	9,097E-1	9,018E-1	9,123E-1	9,125E-1	9,109E-1	9,120E-1	9,108E-1	9,070E-1	9,130E-1	9,002E-1	9,127E-1
λ (nm)	400	9,125E-1	9,140E-1	9,126E-1	9,124E-1	9,108E-1	9,108E-1	9,036E-1	9,130E-1	9,143E-1	9,117E-1	9,137E-1	9,125E-1	9,086E-1	9,139E-1	9,018E-1	9,145E-1
	500	9,150E-1	9,167E-1	9,152E-1	9,155E-1	9,132E-1	9,127E-1	9,069E-1	9,160E-1	9,170E-1	9,142E-1	9,166E-1	9,157E-1	9,116E-1	9,165E-1	9,035E-1	9,173E-1
	600	9,174E-1	9,170E-1	9,163E-1	9,171E-1	9,157E-1	9,160E-1	9,132E-1	9,172E-1	9,184E-1	9,171E-1	9,179E-1	9,176E-1	9,136E-1	9,183E-1	9,074E-1	9,187E-1
	700	9,179E-1	9,180E-1	9,171E-1	9,180E-1	9,163E-1	9,175E-1	9,156E-1	9,183E-1	9,194E-1	9,183E-1	9,187E-1	9,182E-1	9,155E-1	9,198E-1	9,126E-1	9,192E-1
	800	9,176E-1	9,191E-1	9,184E-1	9,188E-1	9,175E-1	9,186E-1	9,167E-1	9,191E-1	9,198E-1	9,193E-1	9,192E-1	9,190E-1	9,161E-1	9,204E-1	9,176E-1	9,198E-1
	900	9,179E-1	9,199E-1	9,188E-1	9,192E-1	9,168E-1	9,190E-1	9,172E-1	9,198E-1	9,203E-1	9,194E-1	9,196E-1	9,194E-1	9,164E-1	9,210E-1	9,180E-1	9,202E-1
	1000	9,184E-1	9,200E-1	9,192E-1	9,196E-1	9,180E-1	9,194E-1	9,174E-1	9,199E-1	9,208E-1	9,199E-1	9,201E-1	9,195E-1	9,169E-1	9,212E-1	9,184E-1	9,205E-1
Filter B	380	4,070E-1	4,042E-1	4,072E-1	4,066E-1	4,126E-1	4,038E-1	4,059E-1	4,066E-1	4,042E-1	4,076E-1	4,040E-1	4,047E-1	4,056E-1	4,114E-1	3,989E-1	4,065E-1
λ (nm)	400	6,039E-1	6,032E-1	6,062E-1	6,056E-1	6,110E-1	6,046E-1	6,059E-1	6,063E-1	6,022E-1	6,059E-1	6,032E-1	6,041E-1	6,051E-1	6,076E-1	5,979E-1	6,054E-1
	500	6,187E-1	6,177E-1	6,205E-1	6,198E-1	6,237E-1	6,187E-1	6,201E-1	6,208E-1	6,171E-1	6,206E-1	6,180E-1	6,185E-1	6,194E-1	6,223E-1	6,133E-1	6,200E-1
	600	6,075E-1	6,061E-1	6,086E-1	6,082E-1	6,129E-1	6,066E-1	6,076E-1	6,087E-1	6,055E-1	6,086E-1	6,060E-1	6,067E-1	6,078E-1	6,114E-1	6,016E-1	6,083E-1
	700	6,359E-1	6,353E-1	6,366E-1	6,365E-1	6,408E-1	6,350E-1	6,352E-1	6,367E-1	6,338E-1	6,369E-1	6,351E-1	6,351E-1	6,359E-1	6,390E-1	6,312E-1	6,366E-1
	800	5,760E-1	5,752E-1	5,769E-1	5,763E-1	5,806E-1	5,743E-1	5,745E-1	5,767E-1	5,738E-1	5,769E-1	5,749E-1	5,745E-1	5,755E-1	5,792E-1	5,712E-1	5,763E-1
	900	5,011E-1	5,000E-1	5,019E-1	5,014E-1	5,059E-1	4,989E-1	4,996E-1	5,019E-1	4,991E-1	5,019E-1	5,000E-1	4,994E-1	5,006E-1	5,044E-1	4,956E-1	5,017E-1
	1000	4,528E-1	4,514E-1	4,536E-1	4,532E-1	4,562E-1	4,504E-1	4,510E-1	4,535E-1	4,510E-1	4,535E-1	4,517E-1	4,511E-1	4,525E-1	4,564E-1	4,469E-1	4,537E-1
Filter C	380	2,096E-2	2,089E-2	2,074E-2	2,198E-2	2,085E-2	2,119E-2	2,056E-2	2,133E-2	2,078E-2	2,091E-2	2,127E-2	2,108E-2	2,079E-2	2,113E-2	2,117E-2	2,183E-2
λ (nm)	400	9,402E-2	9,390E-2	9,341E-2	9,700E-2	9,193E-2	9,437E-2	9,259E-2	9,576E-2	9,360E-2	9,330E-2	9,501E-2	9,476E-2	9,360E-2	9,334E-2	9,445E-2	9,665E-2
	500	9,064E-2	9,046E-2	9,012E-2	9,351E-2	8,919E-2	9,098E-2	8,915E-2	9,209E-2	9,026E-2	9,023E-2	9,155E-2	9,115E-2	9,032E-2	9,100E-2	9,110E-2	9,313E-2
	600	7,589E-2	7,572E-2	7,536E-2	7,832E-2	7,467E-2	7,602E-2	7,488E-2	7,676E-2	7,546E-2	7,580E-2	7,660E-2	7,616E-2	7,555E-2	7,618E-2	7,620E-2	7,793E-2
	700	1,596E-1	1,595E-1	1,587E-1	1,634E-1	1,571E-1	1,600E-1	1,581E-1	1,613E-1	1,591E-1	1,594E-1	1,608E-1	1,601E-1	1,591E-1	1,600E-1	1,603E-1	1,627E-1
	800	1,487E-1	1,484E-1	1,477E-1	1,521E-1	1,466E-1	1,490E-1	1,472E-1	1,501E-1	1,481E-1	1,483E-1	1,497E-1	1,490E-1	1,481E-1	1,491E-1	1,492E-1	1,514E-1
	900	1,017E-1	1,015E-1	1,009E-1	1,044E-1	1,000E-1	1,020E-1	1,005E-1	1,028E-1	1,013E-1	1,015E-1	1,025E-1	1,019E-1	1,012E-1	1,020E-1	1,022E-1	1,036E-1
	1000	7,567E-2	7,547E-2	7,497E-2	7,792E-2	7,423E-2	7,588E-2	7,469E-2	7,646E-2	7,529E-2	7,544E-2	7,634E-2	7,576E-2	7,531E-2	7,588E-2	7,606E-2	7,726E-2
Filter D	380	2,964E-4	2,803E-4	3,316E-4	3,505E-4	2,803E-4	3,542E-4	3,579E-4	3,399E-4	3,586E-4	3,855E-4	3,932E-4	3,862E-4	3,562E-4	3,809E-4	3,784E-4	3,596E-4
λ (nm)	400	5,140E-3	5,071E-3	5,109E-3	5,111E-3	5,082E-3	4,938E-3	5,129E-3	5,140E-3	5,119E-3	5,455E-3	5,322E-3	5,360E-3	5,151E-3	5,108E-3	5,421E-3	5,137E-3
	500	8,397E-3	8,299E-3	8,350E-3	8,298E-3	8,295E-3	8,087E-3	8,399E-3	8,374E-3	8,345E-3	8,880E-3	8,631E-3	8,678E-3	8,367E-3	8,360E-3	8,798E-3	8,356E-3
	600	8,291E-3	8,223E-3	8,249E-3	8,199E-3	8,206E-3	7,996E-3	8,281E-3	8,263E-3	8,241E-3	8,718E-3	8,509E-3	8,566E-3	8,260E-3	8,267E-3	8,691E-3	8,242E-3
	700	2,641E-2	2,622E-2	2,629E-2	2,623E-2	2,621E-2	2,572E-2	2,638E-2	2,641E-2	2,629E-2	2,749E-2	2,697E-2	2,706E-2	2,636E-2	2,631E-2	2,739E-2	2,633E-2
	800	3,211E-2	3,186E-2	3,203E-2	3,189E-2	3,193E-2	3,126E-2	3,207E-2	3,214E-2	3,200E-2	3,353E-2	3,274E-2	3,288E-2	3,207E-2	3,198E-2	3,328E-2	3,200E-2
	900	2,247E-2	2,227E-2	2,239E-2	2,230E-2	2,232E-2	2,181E-2	2,242E-2	2,247E-2	2,238E-2	2,356E-2	2,295E-2	2,307E-2	2,243E-2	2,234E-2	2,337E-2	2,245E-2
	1000	1,663E-2	1,647E-2	1,657E-2	1,650E-2	1,653E-2	1,611E-2	1,660E-2	1,663E-2	1,657E-2	1,750E-2	1,703E-2	1,712E-2	1,661E-2	1,652E-2	1,735E-2	1,664E-2
Filter E	380	6,868E-5	3,223E-5	6,484E-7	2,055E-5	5,416E-5	1,611E-5	-3,176E-5	2,920E-5	1,672E-5	4,085E-5	1,122E-5	1,809E-5	1,137E-5	5,775E-6	9,927E-6	1,178E-5
λ (nm)	400	3,197E-4	3,163E-4	3,600E-4	3,319E-4	3,375E-4	3,476E-4	3,072E-4	3,132E-4	3,463E-4	3,365E-4	2,928E-4	3,199E-4	2,880E-4	3,490E-4	3,113E-4	3,063E-4
	500	9,201E-4	8,847E-4	9,774E-4	9,269E-4	9,948E-4	9,631E-4	8,532E-4	8,800E-4	9,503E-4	9,358E-4	8,316E-4	8,961E-4	8,164E-4	9,508E-4	8,769E-4	8,643E-4
	600	9,801E-4	9,498E-4	1,043E-3	9,872E-4	1,061E-3	1,027E-3	9,094E-4	9,736E-4	1,014E-3	9,824E-4	8,882E-4	9,569E-4	8,708E-4	1,002E-3	9,372E-4	9,218E-4
	700	4,944E-3	4,826E-3	5,178E-3	5,007E-3	5,272E-3	5,147E-3	4,696E-3	4,820E-3	5,113E-3	5,024E-3	4,629E-3	4,865E-3	4,556E-3	5,087E-3	4,833E-3	4,749E-3
	800	9,526E-3	9,301E-3	9,915E-3	9,621E-3	1,005E-2	9,860E-3	9,116E-3	9,245E-3	9,799E-3	9,628E-3	8,958E-3	9,392E-3	8,862E-3	9,761E-3	9,302E-3	9,193E-3
	900	8,312E-3	8,097E-3	8,657E-3	8,389E-3	8,780E-3	8,609E-3	7,934E-3	8,059E-3	8,548E-3	8,415E-3	7,798E-3	8,183E-3	7,710E-3	8,514E-3	8,108E-3	8,003E-3
	1000	7,021E-3	6,836E-3	7,322E-3	7,096E-3	7,434E-3	7,284E-3	6,695E-3	6,799E-3	7,228E-3	7,095E-3	6,567E-3	6,911E-3	6,492E-3	7,201E-3	6,848E-3	6,751E-3

Wavelength	BEV	CMI	GUM	IFA	INM	INRIM	IPQ	METAS	MIKES	MKEH	NPL	PTB	SMU	SP	UME	VSL	
Filter A	380	2,816E-4	5,068E-4	5,026E-4	2,890E-4	1,721E-3	3,830E-4	7,477E-4	4,321E-4	3,141E-4	6,775E-4	2,922E-4	2,836E-4	2,842E-4	4,210E-4	2,837E-4	2,366E-4
λ (nm)	400	2,440E-4	1,866E-4	2,194E-4	1,399E-4	1,592E-3	2,744E-4	2,655E-4	2,697E-4	1,973E-4	2,607E-4	2,439E-4	1,218E-4	1,627E-4	2,777E-4	1,510E-4	1,801E-4
	500	1,375E-4	1,194E-4	1,695E-4	1,604E-4	2,401E-4	1,757E-4	3,451E-4	2,150E-4	1,221E-4	2,607E-4	1,720E-4	1,059E-4	1,378E-4	3,168E-4	1,510E-4	1,302E-4
	600	1,914E-4	1,675E-4	1,601E-4	1,549E-4	6,404E-4	3,748E-4	6,100E-4	1,367E-4	1,969E-4	2,005E-4	1,950E-4	1,180E-4	1,095E-4	2,492E-4	5,390E-4	2,226E-4
	700	1,325E-4	1,161E-4	1,401E-4	1,084E-4	7,616E-4	6,203E-4	1,801E-4	1,939E-4	1,819E-4	1,316E-4	1,551E-4	1,099E-4	1,176E-4	2,019E-4	1,305E-4	8,899E-5
	800	8,638E-5	8,378E-5	8,120E-5	7,831E-5	8,929E-5	7,372E-5	7,536E-5	8,803E-5	2,152E-4	9,084E-5	7,215E-5	2,969E-4	1,090E-4	8,495E-5	7,588E-5	7,418E-5
	900	7,974E-5	7,489E-5	7,851E-5	7,226E-5	8,016E-5	7,823E-5	8,477E-5	7,060E-5	7,080E-5	9,352E-5	7,421E-5	2,788E-4	9,129E-5	9,735E-5	7,685E-5	7,502E-5
	1000	9,463E-5	7,223E-5	8,114E-5	7,236E-5	7,759E-5	7,599E-5	1,261E-4	8,228E-5	2,089E-4	1,172E-4	7,893E-5	1,919E-4	8,365E-5	9,443E-5	9,180E-5	8,271E-5
Filter B	380	4,475E-4	4,831E-4	4,780E-4	4,265E-4	1,997E-3	4,870E-4	6,656E-4	4,586E-4	4,295E-4	6,182E-4	4,403E-4	5,833E-4	4,207E-4	1,026E-3	1,558E-3	4,165E-4
λ (nm)	400	2,595E-4	1,814E-4	1,555E-4	1,160E-4	1,333E-3	7,566E-4	2,029E-4	3,311E-4	1,223E-4	4,705E-4	2,438E-4	1,594E-4	2,566E-4	3,887E-4	2,697E-4	2,363E-4
	500	1,179E-4	1,708E-4	1,745E-4	1,316E-4	1,550E-4	2,294E-4	1,669E-4	1,551E-4	1,199E-4	1,601E-4	9,197E-5	1,063E-4	8,805E-5	7,892E-5	3,135E-4	1,209E-4
	600	1,326E-4	1,728E-4	1,761E-4	1,153E-4	2,607E-4	2,243E-4	1,471E-4	1,483E-4	8,153E-5	1,806E-4	1,029E-4	1,309E-4	1,303E-4	1,665E-4	1,401E-4	1,299E-4
	700	1,090E-4	1,086E-4	1,091E-4	1,320E-4	2,424E-4	1,454E-4	9,905E-5	1,415E-4	9,615E-5	1,987E-4	9,606E-5	8,797E-5	1,020E-4	1,203E-4	1,197E-4	1,067E-4
	800	1,251E-4	1,240E-4	1,506E-4	1,239E-4	1,314E-4	1,230E-4	1,235E-4	1,238E-4	1,428E-4	1,289E-4	1,239E-4	1,248E-4	1,257E-4	1,252E-4	6,607E-4	1,248E-4
	900	1,229E-4	1,227E-4	1,223E-4	1,217E-4	1,247E-4	1,218E-4	1,234E-4	1,220E-4	1,225E-4	1,241E-4	1,224E-4	1,220E-4	1,283E-4	1,260E-4	1,215E-4	1,303E-4
	1000	9,240E-5	9,459E-5	9,743E-5	9,544E-5	9,097E-5	8,823E-5	9,283E-5	8,822E-5	8,759E-5	9,343E-5	8,922E-5	8,856E-5	8,820E-5	8,822E-5	9,728E-5	9,021E-5
Filter C	380	1,561E-4	1,552E-4	1,544E-4	1,549E-4	9,017E-4	2,179E-4	4,306E-4	1,603E-4	1,529E-4	4,845E-4	1,545E-4	1,564E-4	1,566E-4	3,150E-4	1,556E-4	1,534E-4
λ (nm)	400	4,324E-5	4,132E-5	9,266E-5	6,995E-5	4,371E-4	6,120E-5	8,326E-5	4,526E-4	5,920E-5	1,713E-4	4,471E-5	4,264E-5	5,321E-5	1,120E-4	1,808E-4	4,475E-5
	500	4,793E-5	4,068E-5	3,934E-5	3,644E-5	6,160E-5	4,611E-5	4,465E-5	8,464E-5	4,207E-5	4,344E-5	3,608E-5	3,721E-5	3,370E-5	8,236E-5	3,457E-5	4,174E-5
	600	4,938E-5	5,156E-5	4,695E-5	4,902E-5	2,216E-4	4,456E-5	6,555E-5	4,813E-5	5,462E-5	4,901E-5	4,847E-5	4,841E-5	5,168E-5	5,208E-5	4,577E-5	5,430E-5
	700	3,876E-5	5,493E-5	4,773E-5	4,662E-5	2,748E-4	1,121E-4	5,410E-5	6,133E-5	4,289E-5	6,051E-5	4,539E-5	4,262E-5	4,418E-5	5,640E-5	4,043E-5	5,197E-5
	800	1,152E-4	1,149E-4	1,152E-4	1,149E-4	1,156E-4	1,151E-4	1,155E-4	1,153E-4	1,151E-4	1,156E-4	1,152E-4	1,151E-4	1,158E-4	1,149E-4	1,149E-4	1,150E-4
	900	8,109E-5	8,096E-5	8,149E-5	8,093E-5	8,116E-5	1,028E-4	8,103E-5	8,104E-5	8,113E-5	8,104E-5	8,121E-5	8,102E-5	8,113E-5	8,096E-5	8,094E-5	8,109E-5
	1000	6,253E-5	6,265E-5	6,263E-5	6,251E-5	6,283E-5	6,249E-5	6,301E-5	6,282E-5	6,250E-5	6,263E-5	6,253E-5	6,253E-5	6,246E-5	6,284E-5	6,249E-5	6,259E-5
Filter D	380	6,760E-5	6,650E-5	4,937E-5	1,473E-5	5,959E-5	3,911E-5	6,535E-5	3,876E-5	1,524E-5	4,834E-5	1,705E-5	1,944E-5	1,336E-5	6,201E-5	4,176E-5	1,919E-5
λ (nm)	400	4,112E-5	4,345E-5	3,876E-5	8,529E-6	4,438E-5	3,782E-5	4,722E-5	4,031E-5	1,371E-5	4,171E-5	9,765E-6	1,209E-5	1,301E-5	4,330E-5	4,077E-5	1,120E-5
	500	4,726E-5	4,713E-5	4,772E-5	1,078E-5	4,967E-5	4,740E-5	9,506E-5	4,816E-5	7,887E-6	5,190E-5	1,141E-5	1,054E-5	1,446E-5	4,968E-5	4,992E-5	1,080E-5
	600	7,203E-5	6,916E-5	6,643E-5	1,517E-5	6,559E-5	6,408E-5	6,807E-5	6,903E-5	1,336E-5	8,863E-5	1,206E-5	1,352E-5	1,404E-5	6,811E-5	6,999E-5	1,723E-5
	700	1,404E-4	1,376E-4	1,407E-4	2,726E-5	1,749E-4	1,534E-4	1,428E-4	1,401E-4	2,408E-5	1,448E-4	2,358E-5	2,491E-5	2,480E-5	1,680E-4	1,465E-4	2,499E-5
	800	2,618E-5	2,658E-5	2,603E-5	2,616E-5	2,618E-5	2,605E-5	2,629E-5	2,639E-5	2,615E-5	2,781E-5	2,643E-5	2,610E-5	2,608E-5	2,680E-5	2,773E-5	4,534E-5
	900	2,801E-5	2,804E-5	2,786E-5	2,301E-5	2,786E-5	2,765E-5	2,804E-5	2,802E-5	2,305E-5	2,833E-5	2,299E-5	2,310E-5	2,294E-5	2,792E-5	2,821E-5	2,320E-5
	1000	2,859E-5	2,845E-5	2,850E-5	1,734E-5	2,857E-5	2,870E-5	2,868E-5	2,865E-5	1,728E-5	2,944E-5	1,729E-5	1,728E-5	1,731E-5	2,872E-5	2,938E-5	1,755E-5
Filter E	380	6,646E-5	2,138E-5	4,333E-5	9,114E-6	1,995E-5	3,798E-6	2,871E-5	3,541E-5	8,969E-6	2,556E-5	5,059E-6	9,357E-6	6,798E-6	6,716E-5	3,654E-6	1,033E-5
λ (nm)	400	1,444E-5	6,254E-6	7,423E-6	5,154E-6	1,056E-5	3,299E-6	8,310E-6	8,660E-6	4,225E-6	1,276E-5	4,881E-6	4,837E-6	2,800E-6	5,229E-6	4,669E-6	2,443E-6
	500	1,323E-5	5,115E-6	2,938E-6	3,484E-6	2,874E-6	2,325E-6	5,875E-6	4,187E-6	2,541E-6	7,506E-6	3,137E-6	3,944E-6	2,301E-6	1,207E-5	4,398E-6	2,479E-6
	600	4,511E-6	2,109E-5	7,103E-6	3,678E-6	3,469E-6	9,699E-6	4,557E-6	2,812E-5	5,727E-6	1,098E-5	4,341E-6	5,761E-6	4,474E-6	1,202E-5	6,426E-6	3,842E-6
	700	8,195E-6	1,411E-5	9,058E-6	1,027E-5	2,642E-5	1,178E-5	1,056E-5	1,722E-5	9,834E-6	1,183E-5	1,296E-5	9,919E-6	9,803E-6	9,123E-6	4,542E-5	9,451E-6
	800	9,786E-6	1,130E-5	1,036E-5	1,239E-5	1,006E-5	9,819E-6	9,954E-6	1,093E-5	1,191E-5	1,076E-5	1,107E-5	1,079E-5	1,156E-5	1,216E-5	1,006E-5	1,093E-5
	900	8,473E-6	8,545E-6	8,526E-6	9,350E-6	9,025E-6	8,411E-6	8,764E-6	8,667E-6	8,770E-6	8,510E-6	8,714E-6	9,855E-6	9,336E-6	8,641E-6	8,555E-6	8,527E-6
	1000	7,100E-6	7,555E-6	7,180E-6	7,463E-6	7,348E-6	8,121E-6	7,194E-6	7,133E-6	7,575E-6	7,129E-6	1,184E-5	8,494E-6	7,462E-6	7,148E-6	7,590E-6	7,388E-6

	Wavelength	BEV	CMI	GUM	IFA	INM	INRIM	IPQ	METAS	MIKES	MKEH	NPL	PTB	SMU	SP	UME	VSL	
Filter A	380	2,733E-4	5,031E-4	4,988E-4	2,822E-4	1,719E-3	3,774E-4	7,440E-4	4,272E-4	3,080E-4	6,739E-4	2,855E-4	2,768E-4	2,774E-4	4,155E-4	2,769E-4	2,282E-4	
	λ (nm)	400	2,349E-4	1,759E-4	2,099E-4	1,242E-4	1,589E-3	2,674E-4	2,579E-4	2,625E-4	1,874E-4	2,530E-4	2,353E-4	1,048E-4	1,507E-4	2,696E-4	1,334E-4	1,692E-4
	500	1,185E-4	1,013E-4	1,579E-4	1,479E-4	2,308E-4	1,631E-4	3,390E-4	2,059E-4	1,041E-4	2,516E-4	1,604E-4	8,587E-5	1,233E-4	3,093E-4	1,366E-4	1,103E-4	
	600	1,812E-4	1,554E-4	1,478E-4	1,399E-4	6,345E-4	3,668E-4	6,044E-4	1,220E-4	1,864E-4	1,908E-4	1,836E-4	1,007E-4	9,053E-5	2,411E-4	5,305E-4	2,136E-4	
	700	1,174E-4	9,318E-5	1,258E-4	8,795E-5	7,559E-4	6,156E-4	1,691E-4	1,837E-4	1,710E-4	1,161E-4	1,416E-4	9,083E-5	9,905E-5	1,922E-4	1,145E-4	6,420E-5	
	800	4,972E-5	4,797E-5	4,362E-5	3,221E-5	5,281E-5	2,742E-5	3,049E-5	5,532E-5	1,885E-4	5,634E-5	2,164E-5	2,749E-4	7,940E-5	5,040E-5	3,046E-5	2,856E-5	
	900	4,083E-5	3,068E-5	3,630E-5	2,314E-5	3,870E-5	3,278E-5	4,886E-5	1,699E-5	1,795E-5	6,286E-5	2,811E-5	2,575E-4	5,221E-5	6,768E-5	3,390E-5	3,024E-5	
1000	6,471E-5	2,172E-5	4,129E-5	2,026E-5	3,310E-5	2,892E-5	9,802E-5	4,477E-5	1,826E-4	9,278E-5	3,727E-5	1,699E-4	4,789E-5	6,217E-5	6,014E-5	3,965E-5		
Filter B	380	1,639E-4	2,475E-4	2,136E-4	1,097E-4	1,839E-3	2,426E-4	5,101E-4	1,971E-4	1,230E-4	4,069E-4	1,557E-4	3,803E-4	8,739E-5	8,484E-4	1,389E-3	5,307E-5	
	λ (nm)	400	2,498E-4	1,689E-4	1,401E-4	8,714E-5	1,323E-3	7,509E-4	1,917E-4	3,215E-4	1,028E-4	4,626E-4	2,335E-4	1,450E-4	2,475E-4	3,828E-4	2,609E-4	2,267E-4
	500	9,743E-5	1,575E-4	1,613E-4	1,124E-4	1,382E-4	2,192E-4	1,461E-4	1,397E-4	1,001E-4	1,422E-4	6,273E-5	8,153E-5	5,821E-5	3,993E-5	3,013E-4	9,892E-5	
	600	1,137E-4	1,591E-4	1,628E-4	9,294E-5	2,515E-4	2,129E-4	1,306E-4	1,324E-4	4,632E-5	1,678E-4	7,818E-5	1,120E-4	1,117E-4	1,436E-4	1,195E-4	1,107E-4	
	700	8,176E-5	7,147E-5	8,340E-5	1,112E-4	2,278E-4	1,237E-4	6,983E-5	1,199E-4	6,497E-5	1,839E-4	6,540E-5	5,302E-5	7,334E-5	9,494E-5	9,474E-5	8,005E-5	
	800	2,577E-5	1,898E-5	8,478E-5	1,902E-5	4,139E-5	1,164E-5	1,471E-5	1,792E-5	6,571E-5	3,880E-5	1,570E-5	2,203E-5	2,856E-5	2,578E-5	6,049E-4	2,252E-5	
	900	1,941E-5	1,863E-5	1,618E-5	1,116E-5	2,897E-5	1,090E-5	2,239E-5	1,271E-5	1,720E-5	2,477E-5	1,367E-5	1,301E-5	4,155E-5	3,079E-5	7,859E-6	4,459E-5	
1000	3,046E-5	3,500E-5	4,041E-5	3,354E-5	2,548E-5	1,275E-5	3,163E-5	1,329E-5	8,389E-6	3,104E-5	1,894E-5	1,389E-5	1,320E-5	1,340E-5	3,392E-5	1,878E-5		
Filter C	380	2,701E-5	3,068E-5	2,733E-5	2,912E-5	8,397E-4	1,321E-4	3,740E-4	5,062E-5	1,683E-5	4,163E-4	2,788E-5	3,550E-5	3,758E-5	2,403E-4	3,256E-5	2,009E-5	
	λ (nm)	400	2,845E-5	2,828E-5	8,742E-5	6,011E-5	4,341E-4	5,354E-5	7,752E-5	4,507E-4	5,118E-5	1,678E-4	3,277E-5	2,932E-5	4,423E-5	1,069E-4	1,710E-4	3,336E-5
	500	3,626E-5	2,755E-5	2,629E-5	2,163E-5	5,276E-5	3,553E-5	3,330E-5	7,762E-5	2,993E-5	3,070E-5	2,113E-5	2,301E-5	1,633E-5	7,232E-5	1,844E-5	2,886E-5	
	600	2,372E-5	2,954E-5	2,035E-5	2,485E-5	2,109E-4	1,384E-5	4,978E-5	2,303E-5	3,453E-5	2,380E-5	2,233E-5	2,190E-5	2,950E-5	3,030E-5	1,749E-5	3,409E-5	
	700	1,569E-5	4,241E-5	3,248E-5	2,952E-5	2,695E-4	1,046E-4	4,130E-5	4,890E-5	2,500E-5	4,915E-5	2,835E-5	2,379E-5	2,689E-5	4,435E-5	2,036E-5	3,825E-5	
	800	8,648E-6	4,826E-6	8,048E-6	3,522E-6	1,084E-5	6,370E-6	1,128E-5	8,843E-6	6,714E-6	1,212E-5	8,558E-6	7,165E-6	1,383E-5	5,082E-6	4,144E-6	5,859E-6	
	900	5,312E-6	2,921E-6	7,846E-6	2,065E-6	6,448E-6	5,075E-6	4,666E-6	4,707E-6	5,722E-6	4,667E-6	6,345E-6	3,512E-6	6,025E-6	3,101E-6	2,532E-6	4,796E-6	
1000	3,352E-6	4,890E-6	4,907E-6	2,656E-6	6,687E-6	2,359E-6	7,088E-6	6,560E-6	2,473E-6	4,169E-6	3,279E-6	3,235E-6	1,647E-6	6,484E-6	2,457E-6	4,211E-6		
Filter D	380	6,673E-5	6,565E-5	4,813E-5	8,392E-6	5,863E-5	3,499E-5	6,451E-5	3,680E-5	1,089E-5	4,692E-5	1,327E-5	1,629E-5	8,003E-6	6,050E-5	3,914E-5	1,570E-5	
	λ (nm)	400	4,077E-5	4,311E-5	3,828E-5	7,458E-6	4,410E-5	3,722E-5	4,700E-5	3,993E-5	1,306E-5	4,127E-5	8,764E-6	1,135E-5	1,229E-5	4,298E-5	4,029E-5	1,040E-5
	500	4,574E-5	4,581E-5	4,615E-5	8,764E-6	4,872E-5	4,585E-5	9,440E-5	4,694E-5	4,688E-6	5,081E-5	9,507E-6	8,469E-6	1,302E-5	4,875E-5	4,853E-5	8,773E-6	
	600	7,013E-5	6,705E-5	6,407E-5	1,151E-5	6,318E-5	6,146E-5	6,623E-5	6,691E-5	8,985E-6	8,640E-5	6,912E-6	9,167E-6	9,853E-6	6,622E-5	6,782E-5	1,387E-5	
	700	1,371E-4	1,337E-4	1,371E-4	2,102E-5	1,714E-4	1,493E-4	1,400E-4	1,364E-4	1,660E-5	1,414E-4	1,581E-5	1,766E-5	1,763E-5	1,649E-4	1,436E-4	1,787E-5	
	800	1,233E-5	1,399E-5	1,177E-5	1,233E-5	1,258E-5	1,254E-5	1,299E-5	1,327E-5	1,237E-5	1,659E-5	1,233E-5	1,247E-5	1,212E-5	1,408E-5	1,644E-5	3,483E-5	
	900	1,398E-5	1,429E-5	1,300E-5	3,321E-6	1,311E-5	1,308E-5	1,416E-5	1,356E-5	3,333E-6	1,349E-5	2,909E-6	3,960E-6	2,557E-6	1,317E-5	1,366E-5	3,830E-6	
1000	1,912E-5	1,870E-5	1,889E-5	2,603E-6	1,925E-5	2,104E-5	1,989E-5	1,952E-5	2,358E-6	1,968E-5	2,366E-6	2,255E-6	2,337E-6	2,029E-5	2,056E-5	3,326E-6		
Filter E	380	6,645E-5	2,124E-5	4,331E-5	9,087E-6	1,978E-5	3,578E-6	2,870E-5	3,540E-5	8,943E-6	2,554E-5	4,817E-6	9,332E-6	6,763E-6	6,716E-5	3,447E-6	1,031E-5	
	λ (nm)	400	1,433E-5	5,730E-6	7,011E-6	4,899E-6	9,951E-6	2,712E-6	8,143E-6	8,434E-6	3,880E-6	1,265E-5	4,611E-6	4,360E-6	2,185E-6	4,976E-6	4,339E-6	1,774E-6
	500	1,309E-5	4,745E-6	2,353E-6	3,058E-6	2,297E-6	1,595E-6	5,617E-6	3,827E-6	1,893E-6	7,299E-6	2,574E-6	3,573E-6	1,537E-6	1,191E-5	4,006E-6	1,816E-6	
	600	3,738E-6	2,078E-5	6,627E-6	2,774E-6	2,470E-6	8,939E-6	3,630E-6	2,758E-5	5,194E-6	1,010E-5	3,569E-6	5,220E-6	3,735E-6	1,166E-5	5,928E-6	2,989E-6	
	700	6,466E-6	1,336E-5	8,035E-6	9,402E-6	2,559E-5	1,098E-5	9,669E-6	1,661E-5	8,958E-6	1,109E-5	1,226E-5	9,003E-6	8,908E-6	7,893E-6	4,501E-5	8,529E-6	
	800	2,255E-6	5,528E-6	3,796E-6	7,294E-6	3,238E-6	2,294E-6	2,907E-6	4,648E-6	6,078E-6	4,789E-6	5,409E-6	4,876E-6	6,551E-6	6,689E-6	3,132E-6	4,669E-6	
	900	1,356E-6	1,767E-6	1,803E-6	3,766E-6	2,944E-6	1,018E-6	2,287E-6	2,155E-6	2,239E-6	1,574E-6	2,155E-6	5,257E-6	4,197E-6	2,092E-6	1,850E-6	1,700E-6	
1000	8,266E-7	2,377E-6	1,351E-6	2,130E-6	1,806E-6	3,243E-6	1,305E-6	1,070E-6	2,180E-6	1,060E-6	7,716E-6	3,944E-6	2,436E-6	1,166E-6	2,518E-6	2,035E-6		

Wavelength	BEV	CMI	GUM	IFA	INM	INRIM	IPQ	METAS	MIKES	MKEH	NPL	PTB	SMU	SP	UME	VSL	
Filter A	380	9,120E-1	9,118E-1	9,125E-1	9,123E-1	9,128E-1	9,143E-1	9,023E-1	9,129E-1	9,125E-1	9,120E-1	9,121E-1	9,142E-1	9,116E-1	9,132E-1	9,153E-1	0,91323
λ (nm)	400	9,138E-1	9,135E-1	9,143E-1	9,140E-1	9,146E-1	9,160E-1	9,053E-1	9,144E-1	9,142E-1	9,135E-1	9,137E-1	9,161E-1	9,130E-1	9,148E-1	9,173E-1	0,91495
	500	9,163E-1	9,159E-1	9,171E-1	9,169E-1	9,167E-1	9,183E-1	9,106E-1	9,164E-1	9,170E-1	9,159E-1	9,167E-1	9,187E-1	9,155E-1	9,172E-1	9,193E-1	0,91723
	600	9,183E-1	9,174E-1	9,187E-1	9,186E-1	9,180E-1	9,197E-1	9,135E-1	9,178E-1	9,182E-1	9,171E-1	9,181E-1	9,204E-1	9,166E-1	9,188E-1	9,208E-1	0,91865
	700	9,191E-1	9,184E-1	9,201E-1	9,197E-1	9,190E-1	9,203E-1	9,160E-1	9,190E-1	9,191E-1	9,183E-1	9,191E-1	9,217E-1	9,179E-1	9,196E-1	9,217E-1	0,91932
	800	9,199E-1	9,192E-1	9,206E-1	9,203E-1	9,197E-1	9,206E-1	9,176E-1	9,199E-1	9,201E-1	9,189E-1	9,198E-1	9,231E-1	9,189E-1	9,197E-1	9,226E-1	0,92042
	900	9,202E-1	9,196E-1	9,206E-1	9,209E-1	9,202E-1	9,221E-1	9,195E-1	9,199E-1	9,206E-1	9,192E-1	9,202E-1	9,200E-1	9,182E-1	9,214E-1	9,227E-1	0,92083
	1000	9,204E-1	9,199E-1	9,206E-1	9,212E-1	9,205E-1	9,221E-1	9,201E-1	9,208E-1	9,209E-1	9,193E-1	9,205E-1	9,207E-1		9,218E-1	9,231E-1	0,92116
Filter B	380	4,044E-1	4,094E-1	4,079E-1	4,042E-1	4,071E-1	4,073E-1	4,056E-1	4,128E-1	4,095E-1	4,058E-1	4,042E-1	4,050E-1	4,064E-1	4,117E-1	4,201E-1	0,40826
λ (nm)	400	6,058E-1	6,040E-1	6,070E-1	6,054E-1	6,066E-1	6,049E-1	6,049E-1	6,067E-1	6,040E-1	6,055E-1	6,040E-1	6,062E-1	6,053E-1	6,081E-1	5,992E-1	0,60638
	500	6,209E-1	6,187E-1	6,220E-1	6,198E-1	6,225E-1	6,198E-1	6,195E-1	6,211E-1	6,183E-1	6,206E-1	6,194E-1	6,198E-1	6,193E-1	6,228E-1	6,167E-1	0,62073
	600	6,092E-1	6,067E-1	6,101E-1	6,080E-1	6,113E-1	6,083E-1	6,073E-1	6,096E-1	6,067E-1	6,087E-1	6,075E-1	6,077E-1	6,075E-1	6,109E-1	6,049E-1	0,60880
	700	6,366E-1	6,344E-1	6,376E-1	6,361E-1	6,387E-1	6,357E-1	6,352E-1	6,370E-1	6,348E-1	6,363E-1	6,352E-1	6,357E-1	6,353E-1	6,383E-1	6,327E-1	0,63682
	800	5,771E-1	5,738E-1	5,770E-1	5,757E-1	5,789E-1	5,743E-1	5,743E-1	5,766E-1	5,745E-1	5,761E-1	5,747E-1	5,756E-1	5,752E-1	5,780E-1	5,715E-1	0,57689
	900	5,027E-1	4,986E-1	5,038E-1	4,994E-1	5,034E-1	5,083E-1	5,003E-1	5,016E-1	4,996E-1	5,011E-1	4,997E-1	4,992E-1	5,002E-1	5,095E-1	4,985E-1	0,50224
	1000	4,562E-1	4,505E-1	4,553E-1	4,509E-1	4,539E-1	4,592E-1	4,518E-1	4,535E-1	4,516E-1	4,528E-1	4,514E-1	4,515E-1		4,616E-1	4,474E-1	0,45388
Filter C	380	2,040E-2	2,228E-2	2,066E-2	2,150E-2	1,980E-2	2,159E-2	2,050E-2	2,250E-2	2,174E-2	2,068E-2	2,120E-2	2,107E-2	2,076E-2	2,125E-2	2,598E-2	0,02189
λ (nm)	400	9,370E-2	9,406E-2	9,313E-2	9,670E-2	9,218E-2	9,446E-2	9,273E-2	9,566E-2	9,379E-2	9,390E-2	9,483E-2	9,505E-2	9,325E-2	9,446E-2	9,329E-2	0,09656
	500	9,120E-2	6,799E-2*	9,026E-2	9,350E-2	8,973E-2	9,118E-2	8,966E-2	9,207E-2	9,035E-2	9,114E-2	9,198E-2	9,162E-2	9,004E-2	9,114E-2	9,128E-2	0,09340
	600	7,620E-2	7,597E-2	7,570E-2	7,830E-2	7,518E-2	7,656E-2	7,504E-2	7,711E-2	7,577E-2	7,623E-2	7,702E-2	7,643E-2	7,546E-2	7,635E-1	7,656E-2	0,07823
	700	1,592E-1	1,594E-1	1,588E-1	1,633E-1	1,582E-1	1,602E-1	1,582E-1	1,615E-1	1,593E-1	1,596E-1	1,610E-1	1,602E-1	1,586E-1	1,599E-1	1,601E-1	0,16284
	800	1,490E-1	1,484E-1	1,478E-1	1,519E-1	1,470E-1	1,491E-1	1,470E-1	1,500E-1	1,481E-1	1,487E-1	1,498E-1	1,493E-1	1,477E-1	1,488E-1	1,490E-1	0,15163
	900	1,026E-1	1,015E-1	1,018E-1	1,045E-1	9,976E-2	1,057E-1	1,010E-1	1,027E-1	1,012E-1	1,017E-1	1,025E-1	1,020E-1	1,009E-1	1,042E-1	1,038E-1	0,10404
	1000	7,720E-2	7,552E-2	7,565E-2	7,790E-2	7,369E-2	7,857E-2	7,505E-2	7,652E-2	7,529E-2	7,559E-2	7,632E-2	7,592E-2		7,744E-2	7,612E-2	0,07750
Filter D	380	3,400E-4	6,040E-4	3,515E-4	3,000E-4	3,470E-4		3,559E-4	4,065E-4	4,040E-4	3,800E-4	3,710E-4	3,702E-4	3,616E-4	3,590E-4	6,904E-4	0,0003560
λ (nm)	400	5,130E-3	5,240E-3	5,090E-3	5,000E-3	5,067E-3	4,954E-3	5,129E-3	5,166E-3	5,158E-3	5,460E-3	5,284E-3	5,331E-3	5,118E-3	5,165E-3	5,511E-3	0,0050946
	500	8,470E-3	6,292E-3*	8,357E-3	8,300E-3	8,349E-3	8,117E-3	8,378E-3	8,388E-3	8,366E-3	8,930E-3	8,642E-3	8,678E-3	8,349E-3	8,417E-3	8,917E-3	0,0083634
	600	8,300E-3	8,281E-3	8,290E-3	8,200E-3	8,279E-3	8,055E-3	8,300E-3	8,312E-3	8,305E-3	8,820E-3	8,571E-3	8,578E-3	8,275E-3	8,300E-3	8,850E-3	0,0082954
	700	2,640E-2	2,625E-2	2,631E-2	2,620E-2	2,635E-2	2,576E-2	2,637E-2	2,640E-2	2,643E-2	2,757E-2	2,701E-2	2,702E-2	2,628E-2	2,624E-2	2,757E-2	0,0263833
	800	3,220E-2	3,194E-2	3,197E-2	3,180E-2	3,201E-2	3,130E-2	3,201E-2	3,207E-2	3,202E-2	3,350E-2	3,278E-2	3,292E-2	3,196E-2	3,189E-2	3,345E-2	0,0320936
	900	2,260E-2	2,232E-2	2,272E-2	2,230E-2	2,232E-2	2,271E-2	2,257E-2	2,242E-2	2,239E-2	2,353E-2	2,294E-2	2,312E-2	2,235E-2	2,282E-2	2,332E-2	0,0224419
	1000	1,690E-2	1,651E-2	1,683E-2	1,660E-2	1,642E-2	1,671E-2	1,671E-2	1,662E-2	1,659E-2	1,747E-2	1,701E-2	1,716E-2		1,680E-2	1,724E-2	0,0165983
Filter E	380	1,000E-5	3,300E-5	1,241E-5	1,000E-4			1,612E-5	2,108E-5	1,800E-5	1,000E-5	1,035E-5	1,150E-5	1,870E-5	1,341E-5	3,610E-4	0,0000112
λ (nm)	400	3,200E-4	4,220E-4	3,466E-4	4,000E-4	3,567E-4		3,089E-4	3,172E-4	3,470E-4	3,300E-4	2,920E-4	3,191E-4	2,943E-4	3,451E-4	5,914E-4	0,0003042
	500	9,200E-4	9,260E-4	9,713E-4	9,000E-4	9,921E-4	9,689E-4	8,682E-4	8,754E-4	9,570E-4	9,300E-4	8,300E-4	8,995E-4	8,250E-4	9,604E-4	9,391E-4	0,0008666
	600	1,000E-3	1,004E-3	1,043E-3	1,000E-3	1,064E-3	1,040E-3	9,239E-4	9,370E-4	1,026E-3	9,900E-4	8,950E-4	9,604E-4	8,888E-4	1,024E-3	9,556E-4	0,0009291
	700	5,000E-3	4,858E-3	5,196E-3	5,000E-3	5,289E-3	5,182E-3	4,735E-3	4,793E-3	5,141E-3	5,000E-3	4,635E-3	4,859E-3	4,548E-3	5,110E-3	4,843E-3	0,0047569
	800	9,500E-3	9,365E-3	9,918E-3	9,700E-3	1,004E-2	9,878E-3	9,130E-3	9,244E-3	9,804E-3	9,630E-3	9,983E-3	9,392E-3	8,823E-3	9,832E-3	9,311E-3	0,0091875
	900	8,300E-3	8,155E-3	8,944E-3	8,400E-3	8,746E-3	8,965E-3	8,092E-3	8,044E-3	8,552E-3	8,390E-3	7,793E-3	8,232E-3	7,668E-3	8,580E-3	7,883E-3	0,0079895
	1000	7,000E-3	5,151E-3*	7,565E-3	7,100E-3	7,269E-3	7,572E-3	6,846E-3	6,787E-3	7,236E-3	7,080E-3	6,561E-3	6,923E-3		7,480E-3	6,672E-3	0,0067259

* See remark CMI pErreur ! Signet non défini.

	Wavelength	BEV	CMI	GUM	IFA	INM	INRIM	IPQ	METAS	MIKES	MKEH	NPL	PTB	SMU	SP	UME	VSL	
Filter A	380	1,300E-3	3,700E-4	2,840E-4	2,400E-3	7,722E-4	5,444E-4	3,705E-3	3,500E-4	6,000E-4	9,000E-4	6,000E-5	4,900E-4	1,400E-4	1,400E-3	2,210E-4	2,740E-4	
	λ (nm)	400	1,200E-3	3,800E-4	2,840E-4	2,800E-3	6,163E-4	5,280E-4	3,236E-3	2,600E-4	4,000E-4	8,000E-4	7,000E-5	4,900E-4	1,400E-4	1,400E-3	1,922E-4	1,830E-4
		500	1,200E-3	4,000E-4	2,830E-4	5,000E-4	5,518E-4	5,159E-4	2,292E-3	3,100E-4	3,000E-4	8,000E-4	5,000E-5	4,900E-4	1,500E-4	1,400E-3	3,882E-4	2,752E-4
		600	1,400E-3	3,600E-4	2,840E-4	7,000E-4	5,601E-4	5,099E-4	1,813E-3	2,500E-4	3,000E-4	8,000E-4	4,000E-5	4,900E-4	1,500E-4	1,500E-3	3,691E-4	1,837E-4
		700	1,300E-3	3,900E-4	2,840E-4	2,300E-3	5,632E-4	5,143E-4	1,227E-3	2,500E-4	3,000E-4	9,000E-4	7,000E-5	4,900E-4	1,500E-4	1,500E-3	4,253E-4	2,758E-4
		800	1,300E-3	3,700E-4	2,890E-4	6,000E-4	5,632E-4	5,117E-4	6,311E-4	2,500E-4	3,000E-4	9,000E-4	4,000E-5	5,100E-4	1,500E-4	1,600E-3	1,686E-4	1,841E-4
		900	1,300E-3	3,700E-4	2,830E-4	2,100E-3	5,791E-4	5,322E-4	9,965E-4	3,500E-4	4,000E-4	1,000E-3	8,000E-5	1,800E-3	1,600E-4	1,200E-3	3,966E-4	1,842E-4
	1000	1,700E-3	3,800E-4	2,830E-4	2,000E-3	1,153E-3	5,249E-4	9,122E-4	5,900E-4	4,000E-4	1,200E-3	1,300E-4	1,800E-3		1,200E-3	4,980E-4	1,842E-4	
Filter B	380	4,500E-3	2,030E-3	1,630E-4	8,000E-4	3,048E-3	2,473E-3	3,586E-3	8,600E-4	6,000E-4	7,300E-4	1,900E-4	7,200E-4	1,500E-4	1,200E-3	1,573E-3	1,021E-3	
	λ (nm)	400	1,400E-3	2,500E-4	1,400E-4	1,600E-3	3,714E-4	8,000E-4	2,681E-4	1,900E-4	4,000E-4	7,400E-4	9,000E-5	6,100E-4	1,600E-4	8,500E-4	2,758E-4	4,245E-4
		500	1,000E-3	2,800E-4	1,410E-4	4,000E-4	3,226E-4	3,881E-4	4,725E-4	3,700E-4	3,000E-4	7,300E-4	7,000E-5	6,000E-4	1,600E-4	8,500E-4	1,098E-4	4,345E-4
		600	1,100E-3	2,500E-4	1,440E-4	5,000E-4	3,162E-4	3,808E-4	3,021E-4	1,700E-4	3,000E-4	7,200E-4	9,000E-5	6,100E-4	1,500E-4	9,200E-4	9,545E-5	4,262E-4
		700	1,000E-3	3,200E-4	1,470E-4	1,400E-3	3,244E-4	4,035E-4	3,247E-4	1,800E-4	3,000E-4	7,200E-4	7,000E-5	5,800E-4	1,500E-4	9,400E-4	2,289E-4	4,458E-4
		800	1,000E-3	3,000E-4	1,530E-4	4,000E-4	2,638E-4	5,528E-4	4,285E-4	1,700E-4	3,000E-4	7,200E-4	6,000E-5	6,500E-4	1,400E-4	1,100E-3	4,381E-4	4,038E-4
		900	1,100E-3	2,500E-4	1,320E-4	1,000E-3	2,442E-4	5,398E-4	3,201E-4	1,700E-4	3,000E-4	7,200E-4	1,000E-4	2,700E-4	1,400E-4	1,600E-3	2,631E-4	3,516E-4
	1000	1,600E-3	2,400E-4	1,270E-4	1,300E-3	7,117E-4	3,854E-4	4,333E-4	1,800E-4	3,000E-4	7,300E-4	1,300E-4	2,900E-4		1,600E-3	2,457E-4	3,177E-4	
Filter C	380	1,100E-3	7,500E-4	5,300E-5	1,400E-4	5,346E-4	7,457E-4	8,820E-5	1,800E-4	1,300E-4	1,700E-4	6,000E-5	9,400E-5	3,700E-5	2,500E-4	3,617E-4	3,765E-4	
	λ (nm)	400	1,000E-3	8,000E-5	1,330E-4	2,300E-4	2,354E-4	4,776E-4	1,162E-4	8,900E-5	9,000E-5	1,600E-4	5,000E-5	2,200E-4	9,300E-5	2,400E-4	2,015E-4	2,028E-4
		500	5,000E-4	4,000E-5*	1,330E-4	5,900E-5	1,250E-4	1,341E-4	9,090E-5	8,100E-5	7,000E-5	1,500E-4	3,000E-5	2,100E-4	9,200E-5	2,100E-4	1,141E-4	1,961E-4
		600	1,200E-3	9,000E-5	1,220E-4	6,300E-5	1,390E-4	9,628E-5	1,148E-4	3,500E-5	8,000E-5	1,500E-4	4,000E-5	2,100E-4	8,700E-5	2,100E-4	5,751E-5	1,799E-4
		700	1,200E-3	1,000E-4	1,270E-4	3,200E-4	2,900E-4	4,520E-4	1,446E-4	1,500E-4	1,200E-4	1,500E-4	3,000E-5	3,900E-4	1,200E-4	4,200E-4	9,632E-5	3,257E-4
		800	1,100E-3	1,100E-4	1,390E-4	9,800E-5	1,448E-4	2,112E-4	2,413E-4	1,200E-4	1,100E-4	1,600E-4	3,000E-5	4,000E-4	1,200E-4	4,300E-4	1,617E-4	3,033E-4
		900	1,100E-3	7,000E-5	1,340E-4	2,000E-4	1,302E-4	1,976E-4	1,004E-4	6,000E-5	1,000E-4	1,600E-4	2,000E-5	1,400E-4	1,000E-4	5,900E-4	1,200E-4	2,081E-4
	1000	1,100E-3	6,000E-5	1,130E-4	8,400E-5	1,919E-4	7,904E-5	9,957E-5	5,600E-5	8,000E-5	1,700E-4	2,000E-5	1,100E-4		4,600E-4	2,766E-4	1,550E-4	
Filter D	380	8,400E-4	8,000E-5	1,100E-5	2,000E-5	1,142E-5		7,610E-5	4,400E-6	1,400E-5	4,243E-6	4,000E-6	3,000E-6	3,800E-6	9,300E-6	3,501E-5	2,367E-5	
	λ (nm)	400	7,700E-4	5,000E-5	2,000E-5	3,000E-5	2,466E-5	6,305E-5	7,781E-5	1,300E-5	5,000E-6	4,100E-5	6,000E-6	1,700E-5	1,400E-5	2,300E-5	3,459E-5	1,426E-5
		500	7,000E-4	1,000E-5*	2,100E-5	9,600E-6	1,390E-5	1,008E-5	7,635E-5	1,400E-5	7,000E-6	3,600E-5	6,000E-6	2,700E-5	1,900E-5	2,300E-5	3,293E-5	2,509E-5
		600	1,200E-3	4,000E-5	2,300E-5	8,700E-6	1,793E-5	1,936E-5	7,695E-5	1,100E-5	9,000E-6	3,500E-5	7,000E-6	2,700E-5	2,000E-5	2,600E-5	2,979E-5	2,820E-5
		700	1,100E-3	2,000E-5	5,100E-5	5,000E-5	5,540E-5	7,196E-5	7,743E-5	2,300E-5	2,100E-5	3,500E-5	1,600E-5	6,300E-5	4,200E-5	9,000E-5	5,342E-5	7,123E-5
		800	1,000E-3	2,000E-5	5,200E-5	2,500E-5	3,676E-5	3,821E-5	8,976E-5	3,200E-5	2,500E-5	5,600E-5	1,300E-5	1,100E-4	4,800E-5	1,100E-4	4,875E-5	8,023E-5
		900	1,000E-3	2,000E-5	4,100E-5	2,400E-5	2,961E-5	5,075E-5	1,140E-4	2,200E-5	2,000E-5	5,800E-5	8,000E-6	4,200E-5	3,800E-5	2,000E-4	5,292E-5	5,610E-5
	1000	9,000E-4	2,000E-5	3,100E-5	2,100E-5	3,948E-5	1,700E-5	1,047E-4	2,200E-5	1,500E-5	6,100E-5	9,000E-6	3,300E-5		1,900E-4	7,400E-5	4,150E-5	
Filter E	380	8,400E-4	2,000E-5	1,000E-6	5,000E-5			7,621E-5	4,800E-7	4,000E-6	9,220E-7	2,000E-7	2,500E-7	2,100E-6	4,900E-7	3,542E-5	1,485E-6	
	λ (nm)	400	7,700E-4	4,000E-5	1,000E-5	4,000E-5	1,815E-6		7,580E-5	1,400E-6	2,000E-6	9,000E-6	1,000E-6	1,800E-6	3,000E-6	2,600E-6	3,780E-5	1,308E-6
		500	7,000E-4	2,000E-5	1,000E-5	1,000E-5	1,785E-6	9,513E-7	7,575E-5	1,600E-6	3,000E-6	8,000E-6	3,000E-6	2,300E-6	4,400E-6	3,600E-6	2,355E-5	3,553E-6
		600	1,200E-3	3,000E-5	1,000E-5	6,000E-6	2,372E-6	1,147E-6	7,631E-5	1,200E-6	2,000E-6	8,000E-6	2,000E-6	2,400E-6	4,700E-6	4,300E-6	2,606E-5	5,296E-6
		700	1,000E-3	2,000E-5	2,000E-5	1,000E-5	1,179E-5	9,317E-6	7,680E-5	8,100E-6	6,000E-6	1,100E-5	5,000E-6	1,600E-5	1,300E-5	2,200E-5	2,608E-5	1,712E-5
		800	1,000E-3	2,000E-5	2,100E-5	1,000E-5	1,304E-5	4,768E-6	8,167E-5	7,200E-6	8,000E-6	1,200E-5	8,000E-6	2,800E-5	1,900E-5	4,300E-5	2,250E-5	3,216E-5
		900	1,000E-3	2,000E-5	2,000E-5	1,000E-5	1,288E-5	8,501E-6	1,003E-4	8,500E-6	9,000E-6	1,300E-5	5,000E-6	2,800E-5	1,800E-5	1,600E-4	3,503E-5	2,796E-5
	1000	9,000E-4	1,000E-5*	2,000E-5	1,200E-5	2,218E-5	6,730E-6	1,155E-4	1,250E-5	8,000E-6	1,500E-5	6,000E-6	1,400E-5		1,200E-4	7,045E-5	2,354E-5	

* See remark CMI pErreur ! Signet non défini.

Fin du Document