

Technical protocol for BIPM.EM-K10a&b option B comparisons				
Author: Stéphane Solve	Date: 2012/04/16 Version: 3.0	Authorized: Michael Stock	BIPM/ELEC-T-15	

On-site comparison of Josephson arrays

Technical protocol for BIPM.EM-K10.a & b option B comparisons

1. Introduction

The Mutual Recognition Arrangement (CIPM-MRA) among National Metrology Institutes (NMIs) places particular importance on key comparisons to demonstrate an NMI's ability to measure certain critical quantities. The Consultative Committee for Electricity and Magnetism (CCEM) has identified comparisons of Josephson array voltage standards (JAVS) at the level of 1.018 V and 10 V, as key comparisons. These standards are considered as primary voltage standards. To take advantage of the high accuracy of JAVS, on-site direct comparisons have been carried out by the BIPM since 1991. The results are listed in the Key Comparison Database (KCDB) under the identifiers BIPM.EM-K10.a (1.018 V) and BIPM.EM-K10.b (10 V).

In 2004, the BIPM sent a questionnaire to laboratories proposing a new variant of the comparison (identified as Option B), where a stable reference voltage produced across the BIPM Josephson array is measured using the laboratory's Josephson array voltage standard and detector. This makes it possible to carry out a direct comparison using the routine measurement technique used for calibrations in the participating laboratory, requiring only the BIPM array (not both arrays) to maintain a perfectly stable output during the measurements.

2. Purpose

The purpose of the comparison described in this protocol is to compare the voltage reference of the **"name of laboratory (NMI), country"** with that of the pilot (BIPM) in the framework of the BIPM.EM-K10 key comparisons.

The measurements will be made at nominal voltages of **"1.018 V or 10 V"** at the **"laboratory"** between **"dates"**.

Technical protocol for BIPM.EM-K10a&b option B comparisons			
Author: Stéphane Solve	Date: 2012/04/16 Version: 3.0	Authorized: Michael Stock	

This protocol follows the rules of the “Guidelines for CIPM key comparisons” and the “CCEM Guidelines for Planning, Organizing, Conducting and Reporting Key, Supplementary and Pilot Comparisons”. The current version of the CCEM document can be downloaded as a *pdf* file from: <http://www.bipm.org/en/committees/cc/ccem/guidelines.html>

Technical changes to this protocol need to be approved by the CCEM comparison support group.

3. The travelling standard

The travelling standard is the BIPM Josephson array voltage standard, which is composed of the cryoprobe with a 10 V SIS array, microwave equipment and a bias source for the array. To visualize the array characteristic, while keeping the array floating from the ground, an optical isolation amplifier is placed between the array and the oscilloscope. During the measurements, the array is disconnected from its bias source and the oscilloscope. The series resistance of both precision measurement leads is less than 4 Ω , and the value of the thermal electromotive forces (EMFs) is less than 100 nV. The leakage resistance between the precision measurement leads is typically 5 to 7x10¹¹ Ω and is usually checked on-site. This operation is done with a megaohmmeter while the array is not yet mounted on the probe. To verify the step stability, a digital voltmeter is used to measure the voltage across the array using a separate set of leads.

Note: In general, each participating “institute” is responsible for its own costs regarding the measurements, transportation and any customs charges as well as any damage that may occur within its country.

4. The option B

The BIPM offers two variants for performing on-site JAVS keys comparisons. In the one considered here, option B, the BIPM only provides a reference voltage that has to be measured by the “laboratory” using its Josephson standard with its own measuring device. The BIPM array can be floating from ground.

Technical protocol for BIPM.EM-K10a&b option B comparisons				
Author: Stéphane Solve	Date: 2012/04/16 Version: 3.0	Authorized: Michael Stock	BIPM/ELEC-T-15	

5. Organisation of the measurements

After the BIPM equipment has been set up and sufficiently stable conditions have been found (by, for example using the DVM) the standard is connected to the participant's measurement system. The measurement setup is to be simplified compared to the complete Zener calibration setup. The Zener reversing switch is replaced by a simple switch that will close/open the measurement loop. Effectively the reversal polarity of the standards will be performed directly at the level of the JVS with their respective biasing source.

Ten measurement points are acquired following the procedure applied by the participant for routine measurements of Zener standards with the exception that the polarity reversal is performed on both JVS and not from a reversal switch. If the measured voltage difference is repeatable within an acceptable standard deviation, this will be published as the comparison result.

Experience has shown that most direct comparisons of Josephson standards have helped reveal measurement problems such as those associated with leakage resistance, ground loops, etc. If such problems are identified and corrected within the week allotted for the comparison and if this leads to a significantly better comparison result, the CCEM has decided that the new result can be published in the KCDB as if it were the result of a subsequent bilateral comparison.

However in such cases, both results will appear in the tabular form in the BIPM Key Comparison Database (Appendix B of the KCDB : <http://kcdb.bipm.org>) but only the second result will be plotted on the graph.

6. Connections and compatibility requirements

- The output voltage of the BIPM array is accessible on two 5 mm diameter binding posts located at the filter head of the probe holder.
- The probe itself is designed to fit with a PNEUROP NW50 flange type. It requires a clear diameter of 45 mm (Cf. Figure 1) extending all the way down to the helium bath.
- The laboratory is expected to provide a Helium dewar fitted with this type of flange. For any other type of flange, please contact the BIPM to check if an adapter is required.

- The BIPM array probe is inserted through a matching NW50 sliding flange so that a wide range of dewar neck lengths can be accommodated. However, the minimum immersion depth into the liquid helium is 160 mm.
- A 10 MHz reference signal must be provided by the “laboratory”.

« O » Ring

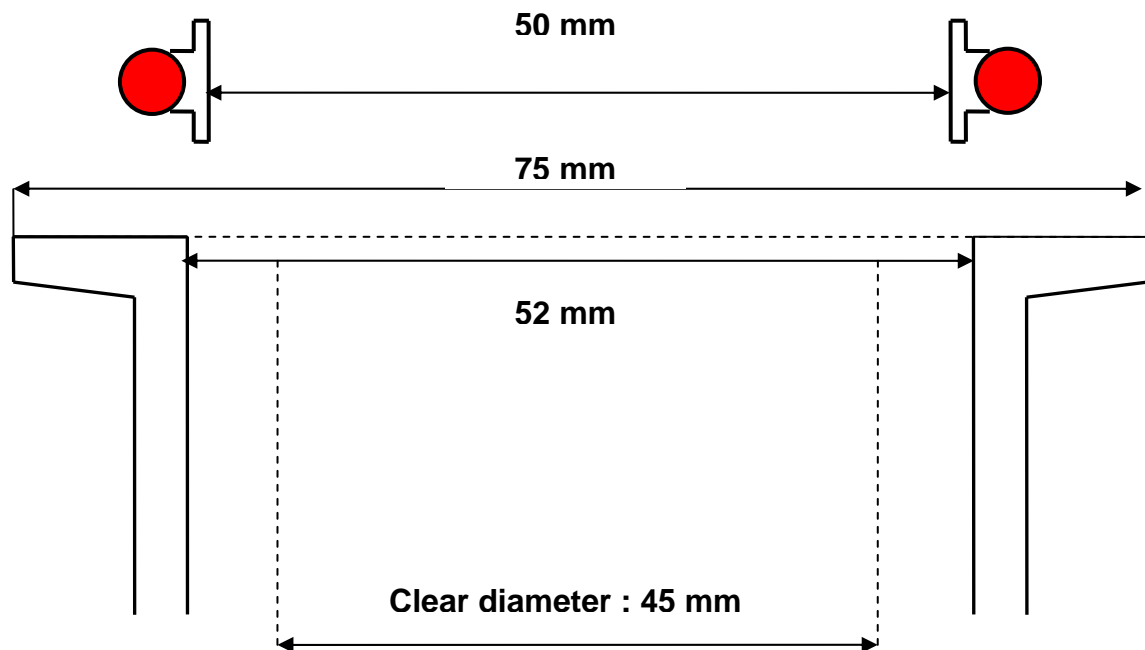

Fig 1. PNEUROP NW50 Flange Type.

7. Participant’s measurement report

The “laboratory” report must be sent to the BIPM within one month from the completion of the measurements.

This report must contain:

- 1- A short description of the measurement method.
- 2 –An uncertainty budget stating the different sources of uncertainty and their values; examples are:

- realisation of the volt representation based on K_{J-90} (uncertainties related to the equipment required to operate the array);
- detector;
- leakage resistance;
- thermal electromotive forces;
- effects of electromagnetic interference.

Technical protocol for BIPM.EM-K10a&b option B comparisons				
Author: Stéphane Solve	Date: 2012/04/16 Version: 3.0	Authorized: Michael Stock	BIPM/ELEC-T-15	

A typical budget for the relative uncertainty of the realization of the volt representation based on K_{J-90} with the BIPM JAVS is given in table 1, for 1 V and 10 V.

Uncertainty component	Type	Relative Uncertainty
Frequency (^a)	B	3.0×10^{-12}
Leakage resistance (^b)	B	8.0×10^{-12}
Total (RSS)	B	8.5×10^{-12}

Table 1. Typical BIPM relative Standard uncertainty components for comparisons at 1 V and 10 V.

The sources of Type B uncertainty (Table 1) are: the absolute value of the frequency measured by the EIP counter (i.e., frequency offset) and the measurement leakage resistance. As the polarities of both arrays are reversed during the measurements, the effect of the residual thermal EMFs (i.e., non-linear drift) is also already contained in the Type A uncertainty of the measurements.

(^a) As both systems are referred to the same 10 MHz frequency reference and most of the effects of the frequency stability will be included in the Type A uncertainty of the measurements, only a Type B uncertainty for systematic errors of the EIP frequency measurement is included.

(^b) The leakage resistance uncertainty is calculated for typical values of the resistance of the measurement leads ($r = 4 \Omega$) and their insulation resistance ($R_L = 5 \times 10^{11} \Omega$). This result is the worst case as all the leakage current is considered flowing through the 4Ω of the measurement leads.

8. Draft A Comparison Report

As pilot laboratory, BIPM will write the comparison report and this includes the items mentioned in the former paragraph.

Technical protocol for BIPM.EM-K10a&b option B comparisons			
Author: Stéphane Solve	Date: 2012/04/16 Version: 3.0	Authorized: Michael Stock	

The result is expressed as the relative difference between the value that would be attributed to BIPM's 10 V Josephson array standard by the "laboratory" ($V_{\text{laboratory}}$) and its theoretical value (V_{BIPM}):

$$(V_{\text{laboratory}} - V_{\text{BIPM}}) / V_{\text{BIPM}}$$

and its relative combined standard uncertainty u_c / V_{BIPM} where u_c is the combined standard uncertainty.

The Draft A report will be sent to the "laboratory" for discussion and approval, normally within two months after completion of the comparison. Upon approval by the participant, it becomes the Draft B report.

As in all key comparisons in the series BIPM.EM-K10.a and BIPM.EM-K10.b, the key comparison reference value will be the voltage value of the BIPM Josephson standard.

9. Impact of the Comparison Result on CMCs

Following the recommendation of the CCEM (25th in April 2007), the BIPM as the pilot laboratory should prepare an executive report that should consist of a compilation of short reports from the participant. The short report should list the CMCs that the participant should expect to be supported by the comparison and describe the measures that will be taken if any of these CMCs are not supported. If any participant does not provide such a report to the pilot laboratory, the pilot laboratory should include a statement in the executive report. Unlike the main report of the comparison, the distribution of the executive report is to be limited to the participant and the members of the WGRMO (Minutes of the 25th CCEM – Appendix E4 - § 4 –p60).

10. Final report

The Draft B report will be submitted to the chairman of the CCEM – WGLF for final approval. In case of unresolved disagreements between the participants concerning the analysis and interpretation of the results the issue will be reported to the *CCEM support group for BIPM Josephson comparisons* who will then seek to settle it.

The Final Report will be submitted to the KCDB manager for inclusion in the KCDB.

Technical protocol for BIPM.EM-K10a&b option B comparisons				
Author: Stéphane Solve	Date: 2012/04/16 Version: 3.0	Authorized: Michael Stock	BIPM/ELEC-T-15	

11. Share of costs

The BIPM covers the travel expenses for the BIPM staff and the cost of the transport of the equipment to the NMI. The NMI is engaged to arrange and pay the transport of the equipment back to the BIPM not later than two weeks after the end of the comparison.

12. Contact persons

Pilot Laboratory Dr. Stéphane SOLVE
 Bureau international des poids et mesures (BIPM)
 Pavillon de Breteuil
 F 92312 Sèvres Cedex France
 Tel.: + 33 1 45 07 70 26
 Fax.: + 33 1 45 07 62 62
stephane.solve@bipm.org

Participant name of the contact person
 “laboratory name”
 “address”
 “Country”
 Tel.:
 e-mail:

13. Revision History

Version number	Date of Issue/Review	Summary of change
Draft 1	06/02/07 to 02/04/07	First version of the document : BIPM internal review
Draft 2	02/04/07 to 20/07/07	Review from the <i>CCEM support group for BIPM Josephson comparisons</i>
Ver 1.0	25/07/2007	Final version V1.0
Ver 2.0	04/09/2008	Revision of the uncertainty budget and insertion in § 8
Ver 2.1	07/01/2009	Revision of the document layout
Ver 2.2	15/01/2010	Annual revision
Ver 2.3	09/07/2011	Clarification of the unc. budget
Ver 3.0	16/04/2012	Inclusion of charging policy, paragraph 11 Attribution of QMS identifier: BIPM/ELEC-T-15, V3.0