

Rapport BIPM-77/7

Intercomparison of high-count-rate ^{60}Co sources

by D. Smith, A. Williams and M.J. Woods

March 1977

BUREAU INTERNATIONAL DES POIDS ET MESURES

F-92310 SEVRES

ABSTRACT

Sources of ^{60}Co with precisely determined relative activities from 2 to 100 kBq have been circulated among eight national and international laboratories. Each participant measured the sources by $4\pi\beta(\text{PC})-\gamma$ counting and evaluated the activities by means of his usual formula. Considerable systematic discrepancies appeared for the higher count rates.

Since an exact solution for an ideal coincidence system was found in the meantime by Cox and Isham, the results of the participants have been recalculated using this new formula. The discrepancies were reduced in nearly all the cases. The correctness of the new formula was verified by Monte Carlo simulations. The remaining discrepancies can be explained by delay mismatch of the β and γ channels and pile-up effects. Other possible causes to be considered are out-of- γ -window events, summing effects and time jitter, which are discussed briefly. Formulae used by the participants are quoted and tables with all the experimental results given. For each set of eight sources and for each laboratory normalized results are presented graphically.

The present comparison was organized in 1975 by the National Physical Laboratory, Teddington, on behalf of the Bureau International des Poids et Mesures. The Comité Consultatif pour les Etalons de Mesure des Rayonnements Ionisants, Section II, decided at its meeting of June 1977 to publish the analysis as a BIPM report. A French translation will appear as an Annex to the Report of that meeting.

1. Introduction

Fourteen sets of ^{60}Co sources were prepared by NPL*, each set consisting of eight sources with approximate activities of 2, 5, 10, 20, 40, 60, 80 and 100 kBq. These sources were prepared from the same stock solution. Eight separate dilutions were made and from each dilution 20 weighed sources and 6 ampoules were prepared. The sources were deposited on Al source mounts ($\approx 250 \mu\text{g}/\text{cm}^2$) and then covered with a gold-coated VYNS film ($\approx 30 \mu\text{g}/\text{cm}^2$ VYNS, $10 \mu\text{g}/\text{cm}^2$ Au). The ampoules were measured in an ionization chamber to check the dilution factors obtained by weighing. All the sources were counted in a $4\pi\beta\text{-}\gamma$ coincidence equipment at NPL. In addition, relative ionization chamber measurements were made on individual sources of activity greater than 40 kBq. These measurements were used, as described below, to reduce the effects of weighing errors. The first sets of sources were then sent to each of the participants (AECL, BCMN, BIPM, IER, LMRI and PTB)* at the beginning of September 1975, two sets being retained at NPL for its own use; subsequently UVVVR* joined in the intercomparison. Each

-
- * AECL : Atomic Energy of Canada Limited, Chalk River, Canada
 BCMN : Bureau Central de Mesures Nucléaires d'Euratom, Geel, Belgium
 BIPM : Bureau International des Poids et Mesures, Sèvres, France
 IER : Institut d'Electrochimie et de Radiochimie de l'Ecole Polytechnique
 Fédérale, Lausanne, Switzerland
 LMRI : Laboratoire de Métrologie des Rayonnements Ionisants, Saclay,
 France
 NPL : National Physical Laboratory, Teddington, United Kingdom
 PTB : Physikalisch-Technische Bundesanstalt, Braunschweig, Germany
 UVVVR : Ústav pro výzkum, výrobu a využití radioisotopů, Praha, ČSSR

participant measured the sources by $4\pi\beta\text{-}\gamma$ counting and evaluated the source activity using his usual count-rate correction formula and his usual procedure for extrapolating to 100% β -detection efficiency. On completion of their measurements on a set of sources, each laboratory returned them to NPL and received another set in exchange; to date each laboratory has measured three to four sets of sources.

2. Monte Carlo simulation and comparison with correction formulae

Monte Carlo simulation was used initially to examine the accuracy of the various count-rate correction formulae used by the participants. However, during the intercomparison, an exact solution for a model that closely approximates the behaviour of real counting systems was found [1]; so this solution, rather than simulation, was then used to correct the results obtained by the participants. The simulation technique was nevertheless still used in order to check (and in all cases confirm) the Cox and Isham formula at various selected values of the relevant parameters.

In the simulation calculation, 'true' values of the source disintegration rate N_0 and ϵ_β (the mean probability of detecting a pulse from a disintegration in an ideal beta detection system without dead time), ϵ_γ , τ_β , τ_γ and τ_r , were chosen arbitrarily (although usually near typical experimental values), and random numbers were used to simulate in the computing what the 'observed scaler counts', N'_β , N'_γ and N'_c , would be from such a source under the assumed values of ϵ_β , ϵ_γ , τ_β , etc. To test, say, the Champion formula [2], these 'observed' counts were substituted into the formula, and the estimate of N_0 obtained in this way was compared to the original value of N_0 used in the simulation. Any discrepancy thereby revealed is a slowly changing function of the parameters involved, N_0 , ϵ_β , ϵ_γ , τ_β , τ_γ and τ_r , and it is not necessary to choose these parameters to be exactly equal to the experimental values.

The computer program was constructed as follows. For a given true disintegration rate N_0 , since the interval distribution for the disintegrations is exponential, a typical time interval between disintegrations

was simulated as $-\frac{1}{N_0} \cdot \ln R_i$, where the random numbers R_i were rectangularly distributed in the range 0 to 1. By summing such time intervals, the 'absolute' time of a disintegration was obtained. Consider a particular disintegration occurring at a time t_0 ; then the β pulse from this disintegration was taken to be detected, for $R_{i+1} < \epsilon_\beta$, and, if detected, it was registered as counted if no other β pulse had occurred from $t_0 - \tau_\beta$ to t_0 . If it was registered as counted, then a coincidence could occur between this β count and a previous γ pulse, provided such a γ pulse had been counted in the time $t_0 - \tau_r$ to t_0 . Similarly, the γ pulse from the same disintegration was taken to be detected for $R_{i+2} < \epsilon_\gamma$, and, if detected, was registered as counted if no other γ pulse occurred from $t_0 - \tau_\gamma$ to t_0 . Again a coincidence could occur between this γ count and either the simultaneous β pulse (if counted), or a previous β pulse, provided such a β pulse had been counted in the time $t_0 - \tau_r$ to t_0 . The next disintegration occurs at $t_0 - \frac{1}{N_0} \cdot \ln R_{i+3}$ and the above procedure is repeated to build up the simulated 'scaler counts' N'_β , N'_γ and N'_c .

The number of disintegrations which must be simulated to obtain, say, 0.1% statistical precision in the estimate of N_0 derived from N'_β , N'_γ , N'_c , depends on the particular parameters, but is of order 10^6 .

The technique has also been extended to allow for 'out-of-channel' events.

3. Problems identified during the intercomparison

As the intercomparison progressed, the following problems associated with making measurements at high count rates were identified by the participants:

- How to ensure that the mean β - γ delay is set to zero? The difficulty arises since the shape of the accidental coincidence distribution is asymmetrical, and to calculate the mean delay it is necessary to know the shape of the accidental distribution under the true coincidence distribution.
- How to allow for the extra dead time introduced by events in the gamma channel which are outside the single-channel analyser window?

- How to allow for summing in the gamma channel, since this can both add to and subtract from true events in the window?
- How to correct for the deficiencies in the present coincidence and dead-time correction formulae? All of the results indicated discrepancies at the highest count rates and simulation calculations showed that a significant part of these discrepancies was due to inadequacies in the present formulae.

These problems will be discussed hereafter.

3.1. Setting of mean delay

This is usually achieved by using a time-to-amplitude converter (TAC) and a multichannel analyser. A possible experimental arrangement is shown in Fig. 1.

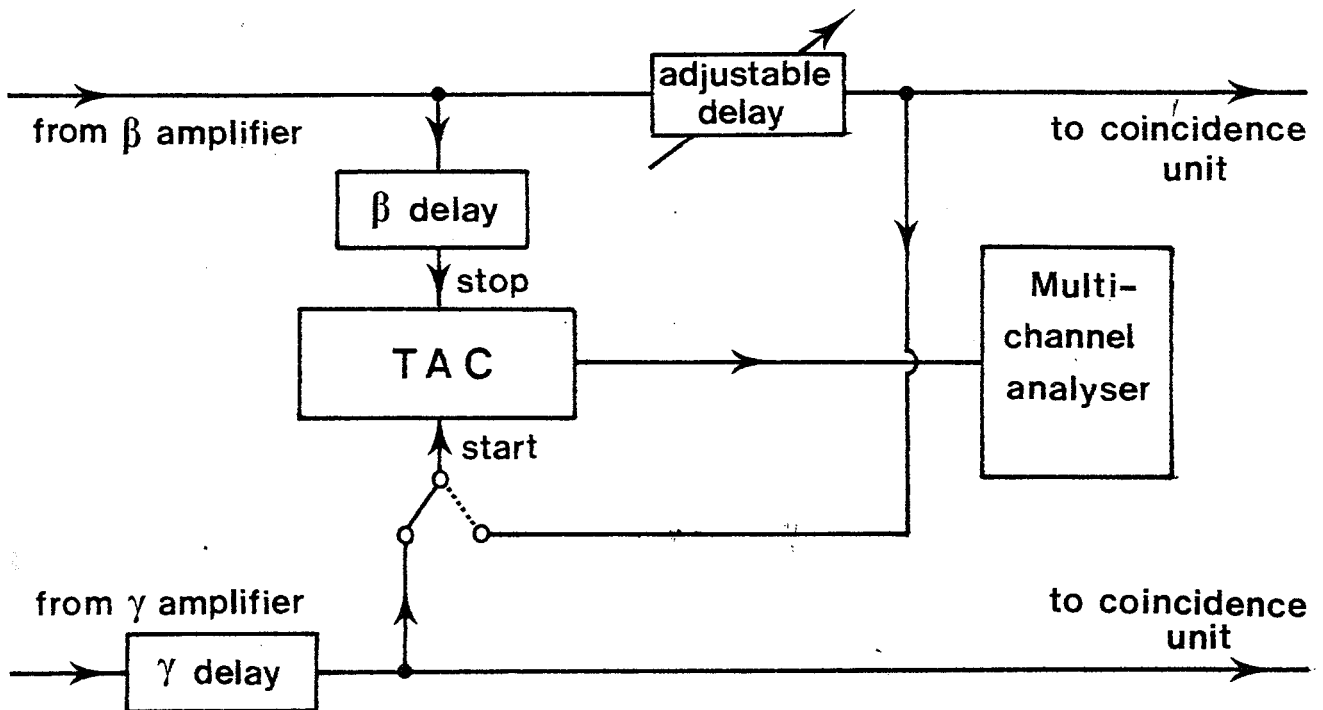

Figure 1 - Principle of the arrangement for determining the time distribution of the β pulses with respect to the γ pulses.

This gives the time distribution of the β pulses with respect to the γ pulses. From this curve one should determine the mean time interval between gamma and beta pulses stemming from the same disintegration.

The calculation of this average delay between the partners forming a genuine coincidence is the main problem. Once this time interval is known, it is a simple matter to set the adjustable β delay by starting the TAC off the β pulses at the entrance of the coincidence mixer until the TAC output falls into the required channel of the analyser. In practice, the TAC full scale plus the β delay is less than the γ dead time, the TAC full scale being approximately $4\tau_r$.

Consider first the case where there is no time jitter and let d be the required (adjustable) β delay to compensate for the relative delay in the β and γ channels. Under these conditions the following are the only possible combinations of start-stop pulses:

- a) Start off γ , stop off a β ray from a previous disintegration (by definition the γ from this previous disintegration was not available to start the TAC).
- b) Start off γ , stop off true coincident β ray.
- c) Start off γ , stop off a β ray from a subsequent disintegration.

Clearly, a), b) and c) are mutually exclusive events since the β dead time precludes two β pulses in the time range being considered. Then for type a) events the interval density is $N_o^2 \epsilon_\beta \epsilon_\gamma (1 - \epsilon_\gamma)$ for $0 < t < d$. The $(1 - \epsilon_\gamma)$ term arises from the fact that the γ pulse, corresponding to the β pulse which stops the TAC, was not itself available to start the TAC. This could be due to γ detector inefficiency, γ channel dead time or TAC and multichannel-analyser dead time. For type b) events, the time distribution is a delta function of height $N_o \epsilon_\beta \epsilon_\gamma$ at time d . For type c) events the interval density is $N_o^2 \epsilon_\beta \epsilon_\gamma (1 - \epsilon_\beta)$ for $d < t < t_{\max}$, where t_{\max} is the maximum range of the TAC. These interval densities are shown in Fig. 2.

The centroid \bar{x} of the interval density from channel n_1 to n_2 is given by

$$\bar{x} = \left(\sum_{r=n_1}^{n_2} r Y_r \right) / \left(\sum_{r=n_1}^{n_2} Y_r \right),$$

where Y_r is the contents of the r^{th} analyser channel. The problem now is to find the relationship between \bar{x} and the centroid d of the interval density b) (including time jitter).

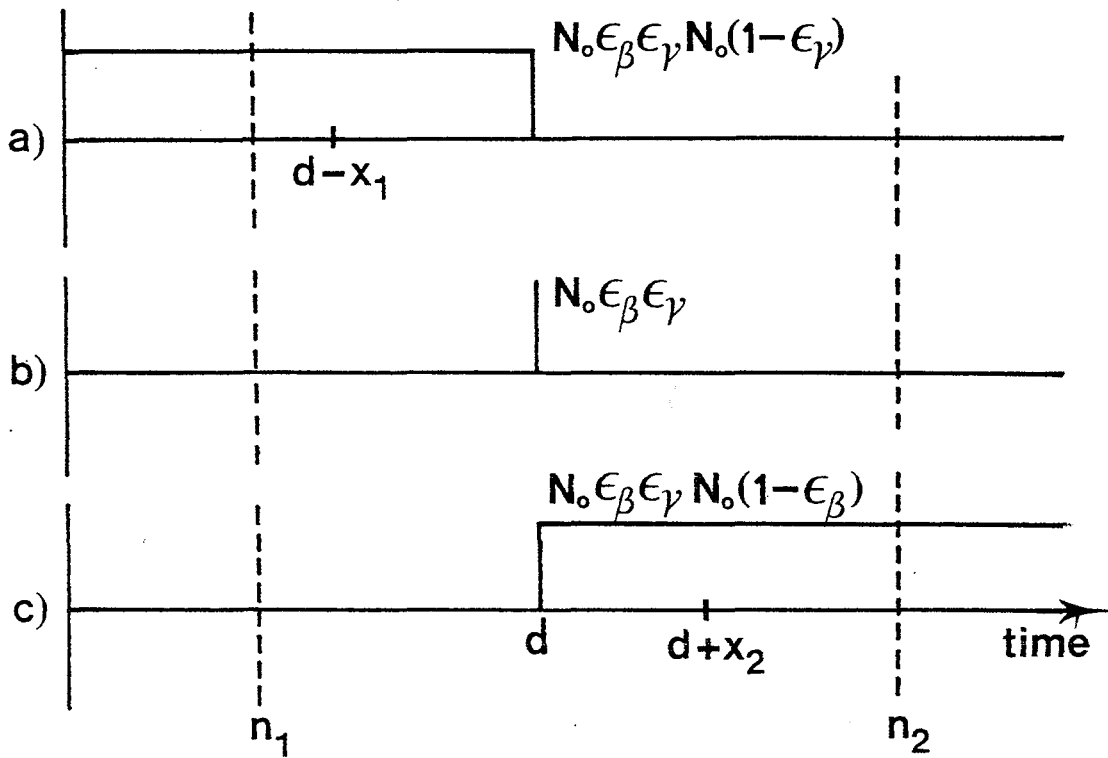

Figure 2 - The three possible probability densities for the time intervals between γ and β pulses as determined by the equipment of Fig. 1 (without time jitter).

The start is always off a γ ray, whereas the stop is

- a) off a β ray from a previous decay event,
- b) off a true coincident β ray,
- c) off a β ray from a subsequent decay event.

For the density a) let the centroid from channel n_1 be at $d - x_1$ and W_1 be the total counts in this region. For b) let the centroid be at d with W_2 counts and for c) at $d + x_2$ with W_3 counts. Then

$$\bar{x} = \frac{W_1 (d - x_1) + W_2 d + W_3 (d + x_2)}{W_1 + W_2 + W_3}$$

$$= d + \frac{W_3 x_2 - W_1 x_1}{W_1 + W_2 + W_3} = d + \Delta .$$

In practice $W_2 \gg W_1$ or W_3 , and the height of density c) is much greater than that of a). Hence

$$\Delta \approx \frac{W_3}{W_2} \cdot x_2 = 2(1 - \varepsilon_\beta) N_o x_2^2.$$

It is difficult to allow exactly for the effect of time jitter on the above estimate of Δ , but it is clear that it should reduce its value, since some counts of the distribution c) will come below the channel d and hence reduce the value of x_2 .

As it is usual to determine the mean channel by summing over just those channels contributing to the genuine coincidence distribution, x_2 is approximately $\tau/4$, where τ is the width of the coincidence distribution. Thus

$$\Delta \approx \frac{N_o \tau^2}{8}.$$

For $N_o = 10^5$ Bq and $\tau = 0.8 \mu\text{s}$, one gets $\Delta \approx 10$ ns, which would introduce about 0.1% error at this value of N_o .

The value of Δ depends on the source disintegration rate and hence the mean channel should vary with disintegration rate if Δ is significant. At NPL it was found that the position of the mean channel, obtained from the genuine coincidence distribution, does not change by more than 5 ns from β count rates between 10^4 and 10^5 s^{-1} .

3.2. Effect of genuine out-of-window γ events in the γ -channel chain

a) Resolving time correction (Campion formula [2])

In deriving this correction it is usual to assume that all β pulses not accompanied by an in-window γ event are available for producing an accidental coincidence. However, some of these β pulses are accompanied by out-of-window γ events and since the γ channel is then dead, these β pulses cannot contribute to the accidental coincidences.

The rate of β pulses without a genuine γ event (in- or out-of-window) is $N'_\beta - N_{cT}$, where N'_β is the observed β rate and N_{cT} is the true coincidence rate between β events and in-window and out-of-window γ events.

The accidental coincidence rate produced by these pulses is $(N'_\beta - N_{cT}) \tau_r N'_{\gamma I}$, where $N'_{\gamma I}$ is the observed in-window γ rate.

For unaccompanied γ 's the accidental rate is $(N'_{\gamma I} - N_{cl}) \tau_r N'_\beta$, where N_{cl} is the true in-window coincidence rate.

Thus

$$N_{cl} = \frac{N'_{cl} - 2 \tau_r N'_\beta N'_{\gamma I}}{1 - \tau_r \left[N'_\beta + N'_{\gamma I} \frac{N_{cT}}{N_{cl}} \right]}$$

$$\approx \frac{N'_{cl} - 2 \tau_r N'_\beta N'_{\gamma I}}{1 - \tau_r (N'_\beta + N'_{\gamma T})}$$

total (in + out)

since $N'_{\gamma I} \frac{N_{cT}}{N_{cl}} \approx N'_{\gamma T}$,

where $N'_{\gamma T}$ is the observed in-window plus out-of-window γ rate and N'_{cl} is the observed coincidence rate.

b) Dead-time corrections

- γ channel

$N_{\gamma I} = N'_{\gamma I} + N_{\gamma I} \times (\text{fraction of time that } \gamma \text{ channel is dead}),$

i.e.

$$N_{\gamma I} = \frac{N'_{\gamma I}}{1 - N'_{\gamma I} \tau_{\gamma I} - N'_{\gamma O} \tau_{\gamma O}} \equiv \frac{N'_{\gamma I}}{1 - N'_{\gamma I} \tau_{\gamma \text{eff}}}$$

where $\tau_{\gamma I}$ = in-window dead time,

$\tau_{\gamma O}$ = out-of-window dead time,

$$\tau_{\gamma \text{eff}} = \frac{N'_{\gamma I} \tau_{\gamma I} + N'_{\gamma O} \tau_{\gamma O}}{N'_{\gamma I}} .$$

- Coincidence channel

$N_{cl} = N'_{cl} + N_{cl} \times$ (fraction of time that either the β or γ channel is dead). Neglecting the effect of overlapping β and γ dead times from non-coincident events, there are five types of events to be considered:

Type	Rate	Time coincidence channel dead
β , no γ	$N'_{\beta} - N'_{cl}$	τ_{β}
β , γ in-window	N'_{cl}	$\max(\tau_{\beta}, \tau_{\gamma I})$
β , γ out-of-window	N'_{co}	$\max(\tau_{\beta}, \tau_{\gamma o})$
no β , γ in-window	$N'_{\gamma I} - N'_{cl}$	$\tau_{\gamma I}$
no β , γ out-of-window	$N'_{\gamma o} - N'_{co}$	$\tau_{\gamma o}$

Hence

$$N'_{cl} = N_{cl} \left[1 - N'_{\beta} \tau_{\beta} - N'_{\gamma I} \tau_{\gamma I} - N'_{\gamma o} \tau_{\gamma o} + N'_{cl} \tau_{cl} + N'_{co} \tau'_{co} \right]$$

$$= N_{cl} \left[1 - N'_{\beta} \tau_{\beta} - N'_{\gamma I} \tau_{\gamma eff} + N'_{cl} \tau_{cl} + N'_{co} \tau_{co} \right],$$

where

$$\tau_{cl} = \min(\tau_{\beta}, \tau_{\gamma I})$$

and

$$\tau_{co} = \min(\tau_{\beta}, \tau_{\gamma o}).$$

Thus the final formula becomes

$$\frac{N_{\beta} N_{\gamma I}}{N_{cl}} = \frac{N'_{\beta} N'_{\gamma I} \left[1 - \tau_r (N'_{\beta} + N'_{\gamma I}) \right] \left[1 - N'_{\beta} \tau_{\beta} - N'_{\gamma I} \tau_{\gamma eff} + N'_{cl} \tau_{cl} + N'_{co} \tau_{co} \right]}{(N'_{cl} - 2 \tau_r N'_{\beta} N'_{\gamma I}) (1 - N'_{\beta} \tau_{\beta}) (1 - N'_{\gamma I} \tau_{\gamma eff})}$$

3.3. Effect of random summing in γ channel

Events can be lost from the γ window by being lifted out of the window by the arrival of a second in-window event or out-of-window event of sufficient amplitude within some time τ_x , where τ_x depends on the pulse

shape and size and also on the mode of operation of the single channel analyser. Extra in-window events can be observed due to the random summation of γ pulses of amplitude less than the window threshold.

A full calculation of these effects would be very difficult to perform, since they depend on the spectrum shape and on a knowledge of the value of τ_x as a function of pulse amplitude. However, like normal dead-time losses, the losses due to these effects are proportional to the square of the disintegration rate and can therefore be corrected for, to first order, by adding an extra term to the γ dead-time correction, i.e.

$$N_{\gamma l} = \frac{N'_{\gamma l}}{1 - N'_{\gamma l} (\tau_{\gamma \text{eff}} + \tau')},$$

where τ' is a constant for a particular γ window setting and a particular nuclide.

The two-source method of measuring the dead time gives the value of $\tau_{\gamma \text{eff}} + \tau'$, and application of this method gave a value of $\approx 2 \mu\text{s}$ for τ' for the equipment used at NPL. This extra term τ' is also added to the value of $\tau_{\gamma \text{eff}}$ in the coincidence-channel dead time and hence the effect of including the term is to alter N_o by $(1 - N'_\beta \tau_\beta N'_\gamma \tau')$. Hence for $N_o \approx 10^5 \text{ Bq}$, $\epsilon_\beta = 0.9$, $\epsilon_\gamma = 0.1$, $\tau_\beta = 1.5 \mu\text{s}$, $\tau' = 2 \mu\text{s}$, applying this correction for τ' reduces N_o by 0.3%.

3.4. Discrepancies at high count rates

As was pointed out in the introduction, all the sources were prepared from the same stock solution and hence their relative activities are known to within the precision of the source preparation procedure. For sources with activities higher than about 40 kBq the relative activities were determined at NPL to a precision better than 0.1% using an ionisation chamber, and these values were confirmed by γ -spectrometry measurement at LMRI. From these measurements a 'best estimate' of the activity for each source was obtained.

Since the measurements of the sources were performed over a period of about two years, the Cox and Isham correction factor applied to any measurement was calculated for the disintegration rate at the time of measurement and not at the reference time.

It will be seen that in all cases the results obtained by the participants show a systematic trend with count rate which is unlikely to be due to the normalisation procedure, particularly as in all cases the largest discrepancies occur in the region where it is possible to have the greatest confidence in the relative activity measurements. The use of the Cox and Isham formula [1] in nearly all cases gives a significant reduction in the discrepancy at high count rates. Since simulation calculations in all cases confirmed the Cox and Isham formula, it is safe to assume that the residual discrepancies are due to the non-ideal behaviour of the coincidence equipment used and some possible reasons for this are discussed in the next section.

4. Some remarks on the influence of pile-up effects (by J.-J. Gostely)

The results obtained at IER using the Campion formula [2] showed (Fig. 3) that quite a good estimate of the activity could be obtained with the usual operating conditions of dead time (2.201 μs in the β channel and 2.196 μs in the γ channel) and resolving time (0.775 μs). However, this agreement is fortuitous and is not obtained when other values of the counting parameters are used.

When the Cox and Isham formula [1] became available, the results were re-calculated. The values obtained (Fig. 3) confirmed the NPL simulations and showed a clear and increasing systematic deviation with increasing activity. Since it is clear that the Cox and Isham derivation is correct, this deviation must arise from a significant difference between the mathematical model used and the IER equipment.

The model used by Cox and Isham assumes that in each counting channel the Poisson process is perturbed by a constant non-cumulative dead time. However, this is not so for the IER equipment. There exists an intermediate state between the original Poisson process and the state where

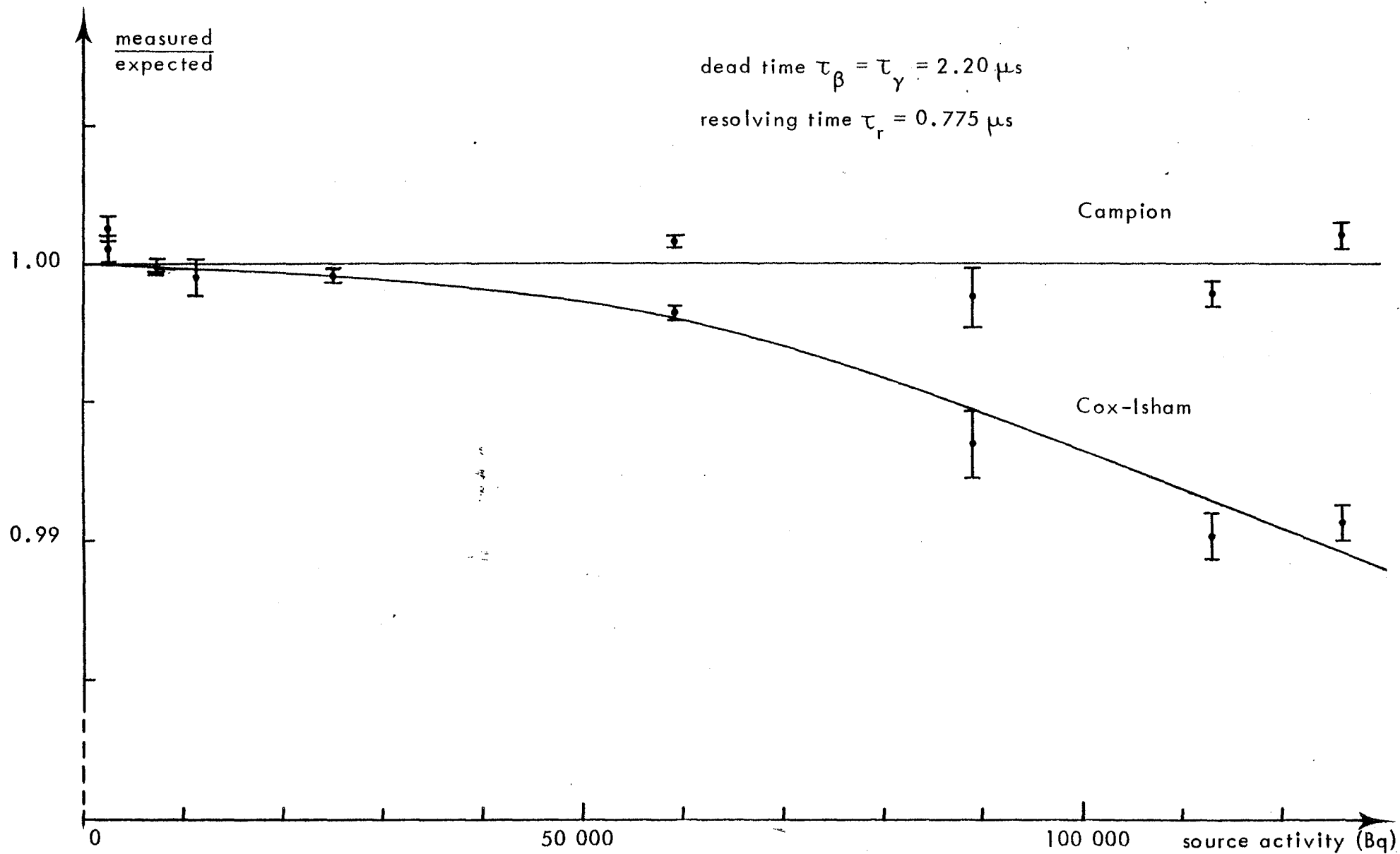

Figure 3 - Ratio of the measured activity to the expected activity, using either the Campion formula or the Cox and Isham formula, as a function of the activity of the ^{60}Co sources. The points and deviations are the mean and its standard deviation of four sets of sources from NPL measured at IER.

the perturbation by the dead time occurs. (It seems that the proportional counter has a negligible dead time). The effect of this intermediate state is illustrated in Fig. 4, where the signal shapes at the input and output of a double-delay-line amplifier are shown (Fig. 4a). When two events fall within an interval smaller than the shaping time constant, pile up occurs. In the situation shown in Fig. 4b, the output signal from a zero-crossing timing discriminator will produce a logical output related to the second event. Unfortunately, however, such cases where the behaviour of the equipment is obviously different from the mathematical model occur frequently at high count rates. For a detection rate of 10^5 s^{-1} the probability of having intervals smaller than $1 \mu\text{s}$ is about 10%.

Figure 5 shows the results of the measurements of a 102 kBq source for different settings of the resolving time. An inflexion point occurs for a resolving time close to $1 \mu\text{s}$, irrespective of the formula and the dead time used. The Campion formula gives a good agreement (Fig. 5a) only for a resolving time of $0.8 \mu\text{s}$ and a dead time of $2.20 \mu\text{s}$. These are the conditions which were used for the intercomparison. For a different dead time (Fig. 5b), the resolving time which leads to a satisfactory agreement is also different, and this indicates that the agreement may be due to a fortuitous compensation of the shortcomings in the equipment by those of the Campion formula. Initially the Cox and Isham formula gives good agreement, irrespective of the dead time, for a relatively large range of resolving time beginning at $1 \mu\text{s}$.

The results of an experiment in which a source of 111 kBq was measured with increasing dead times are shown on Fig. 6 and confirm the correctness of the new formula. The losses due to the non-cumulative dead time reach 75% in the beta channel for the maximum dead time value of $29.2 \mu\text{s}$. The systematic deviation of about 1% is due to the pile-up effect or, in other words, to the inadequate resolving time used in this equipment.

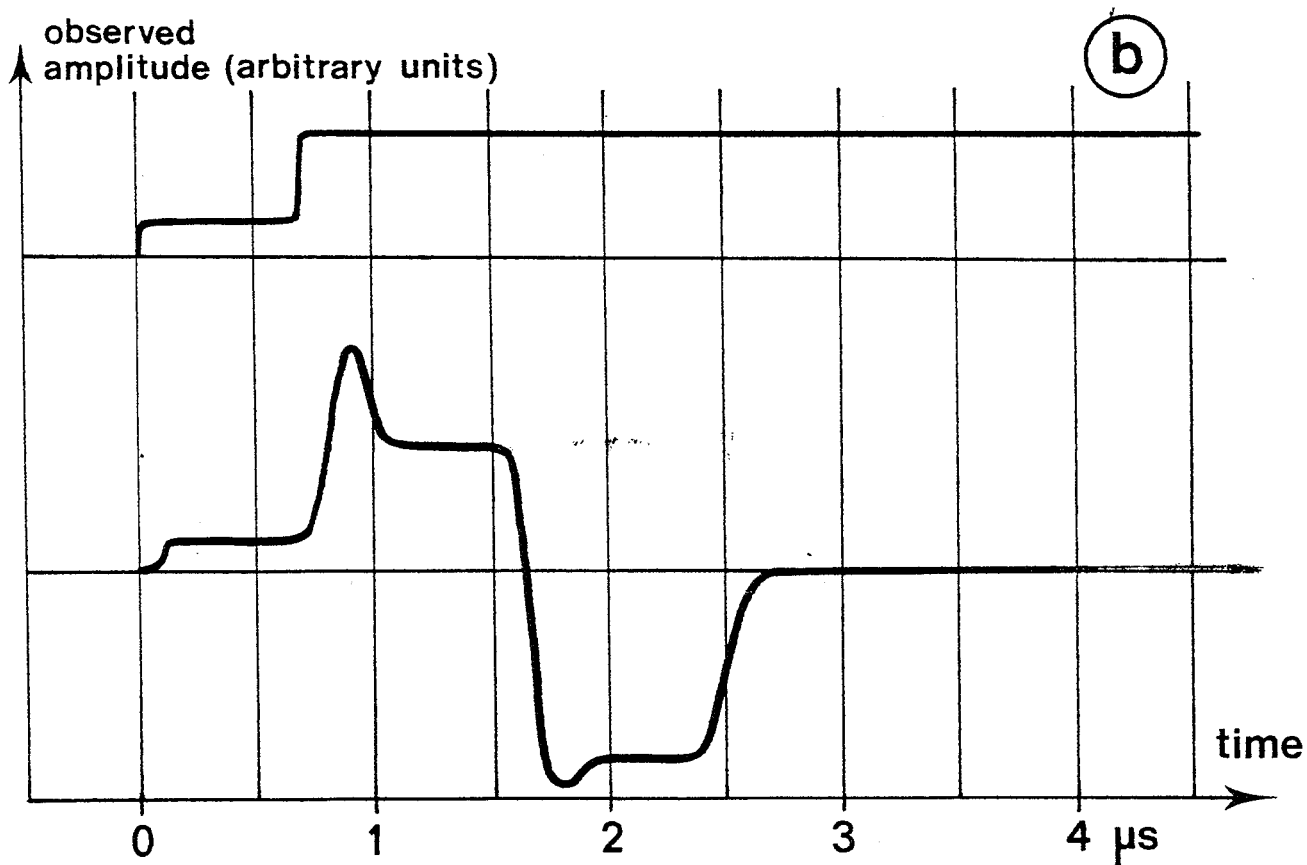
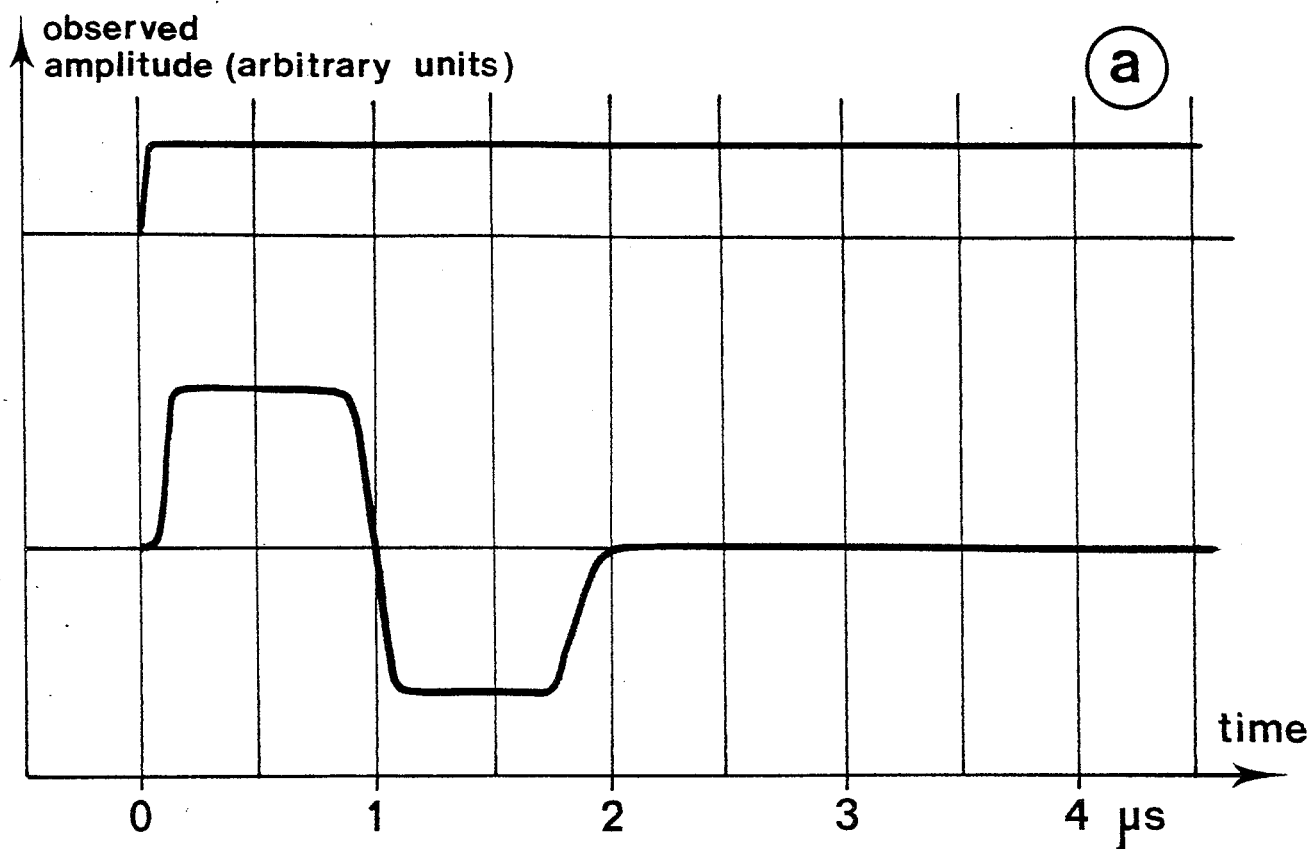

Figure 4 - a) Upper part: output signal from the 4π proportional counter preamplifier; simulated with a pulser.
Lower part: output signal of double delay line amplifier with shaping constant of about $1 \mu\text{s}$.

b) Upper part: output signal of the preamplifier for two simulated events in an interval less than $1 \mu\text{s}$.
Lower part: corresponding signal at the output of amplifier.

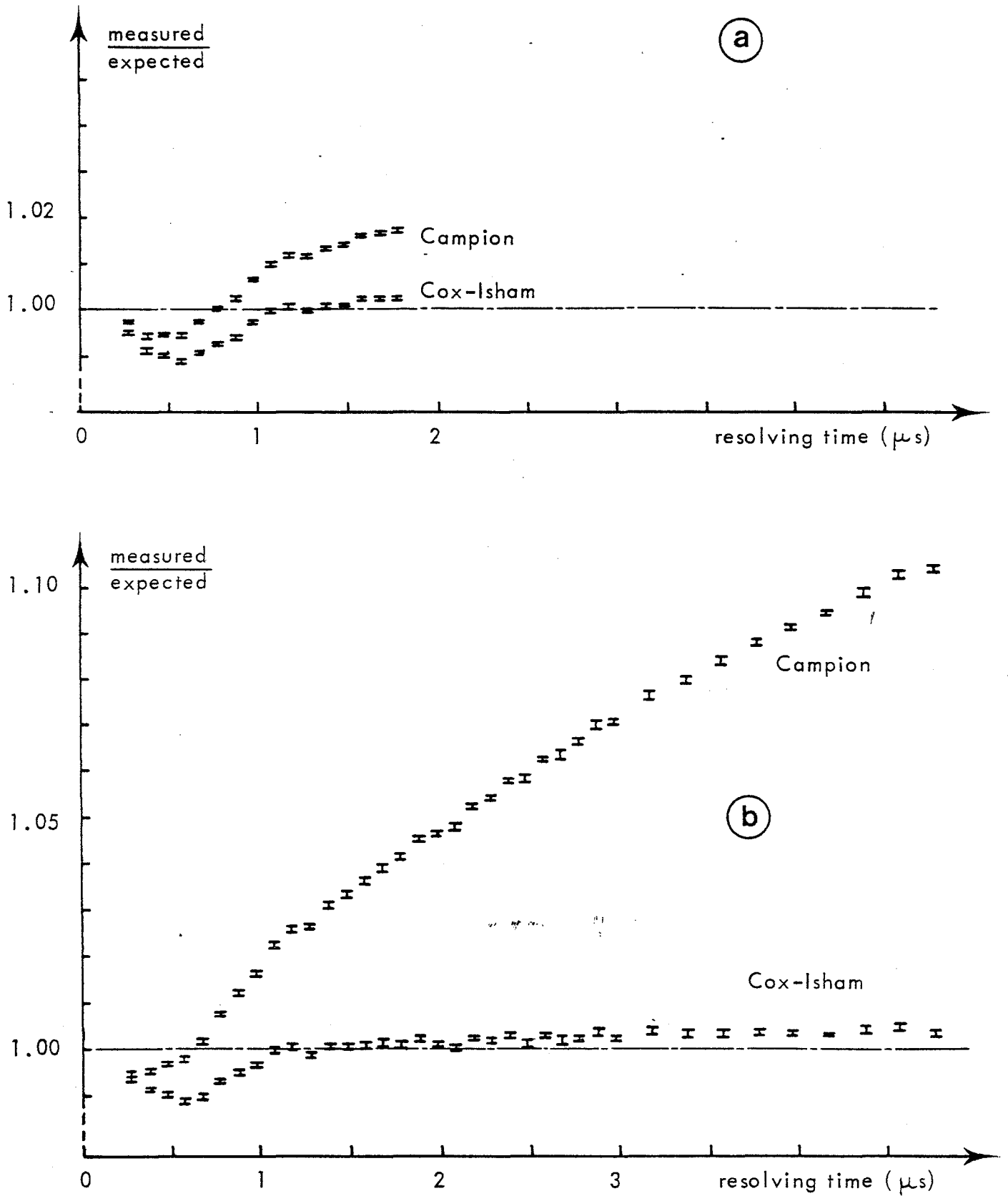

Figure 5 - Ratio of the measured activity to the expected activity for a 102 kBq ^{60}Co source, as a function of the resolving time, using either the Champion formula [2] or the Cox and Isham formula [1].
 a) Dead time $\tau_{\beta} = \tau_{\gamma} = 2.20 \mu\text{s}$,
 b) " " $\tau_{\beta} = \tau_{\gamma} = 6.20 \mu\text{s}$.

source activity : 111 kBq
 resolving time : 0.775 μ s

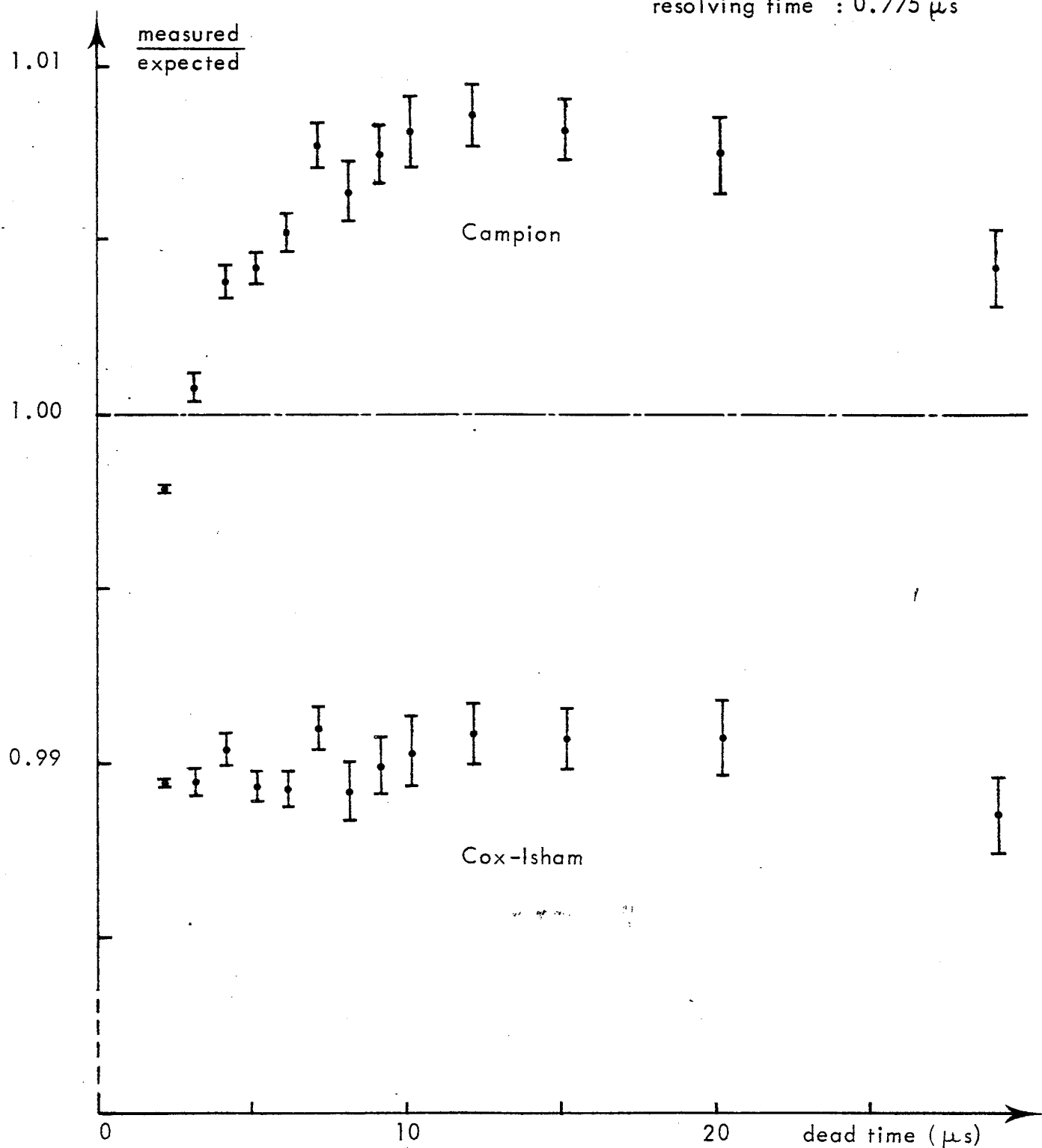

Figure 6 - Ratio of the measured activity to the expected activity for a 111 kBq ^{60}Co source, as a function of the imposed non-cumulative dead time, using either the Campion formula [2] or the Cox and Isham formula [1], and a resolving time of 0.775 μ s.

We have attempted to describe to a first approximation the timing distortions resulting from this pile-up effect and to include them, if possible, in the derivation of the true coincidence rate. However, this appears to be difficult because the five terms, the sum of which is equal to the observed coincidence rate in [1], become fifteen in the derivation taking into account the pile-up effect.

Another way would be to improve the instrumentation. Therefore, in the future additional effects like pile up, time jitter and the Gandy effect [3] will have to be taken into account.

5. Areas requiring further investigation

The effect of time jitter and non-zero mean delay is not treated in [1] and further work is required* to obtain even a good estimate of these effects. A parameter p_{12} is defined in [1] which is the probability that both channels are live. In the case of zero time jitter this would be a simple parameter to measure experimentally, but clearly time jitter affects the overlap dead time for the coincidence events. Thus the experimental value of p_{12} will be different from the theoretical value. However, it is yet to be determined which gives a better description of the real situation for determining the count rate correction.

The correction for the dead time introduced by out-of-channel events, for the case where all gamma events are subjected to the same dead time, can be dealt with by a simple extension to the Cox and Isham approach [5], but the case where the out-of-channel events have a different dead time has not yet been solved. Neither has it been possible to include the effects due to summing in an exact manner. In the case of the NPL results, the value of τ_y used was determined using a variant of the two-source method and hence at least contains some compensation for summing.

* For the case of an extended dead time, see [4].

For most of the results the ratios of observed/expected values using the Cox and Isham formula show an approximately linear relationship with count rate and it is interesting to speculate that the discrepancy between the observed and expected values is due to errors in either the mean β - γ delay δ , or in the values of τ_r , τ_β or τ_γ . Table 1 gives the values of δ required to account for the observed discrepancies. Alternatively, τ_r would have to be in error by about the same amount, or τ_β or τ_γ in error by approximately ten times as much.

Table 1

<u>Laboratory and measurement conditions</u>		<u>δ (in ns)</u>
AECL	(A)	2
	(B)	- 4
	(C)	- 9
	(D)	- 31
BIPM	(A)	46
	(B)	0
LMRI	(A)	117
	(B)	48
	(C)	62
	(D)	50
	(E)	33
NPL		19
PTB	(A)	30
	(B)	4
	(C)	36
UVVVR	(A)	- 4
	(B)	- 8
	(C)	27
	(D)	1
	(E)	
	(F)	15

Such large errors in the values of τ_β , τ_γ or τ_r do not seem reasonable but errors of this size could occur in δ .

The detectors and electronic circuits used in this intercomparison were practically identical with those described in [5].

Formulae

The following equations were used by the participants to evaluate the activity N_o of the sources. The meaning of the symbols is standard, except for

N' = observed count rate,

N = background corrected count rate.

(A), (B), ... stand for the measurement conditions of the various laboratories.

1. AECL - Gamma-gate setting: 1 035 to 1 580 keV

$$N_o = \frac{N_\beta N_\gamma [2 - N'_\beta \tau_\beta - N'_\gamma \tau_\gamma + 2 N'_c \tau_c - 2 (N'_\beta \theta_\gamma + N'_\gamma \theta_\beta) + 2 \delta (N'_\beta - N'_\gamma)]}{[N'_c - N'_\beta N'_\gamma (\theta_\beta + \theta_\gamma)] (2 - N'_\beta \tau_\beta - N'_\gamma \tau_\gamma)}$$

see [7], eq. 4

(A), (B), (C) and (D) $\epsilon_\beta \approx 0.92$, $\epsilon_\gamma \approx 0.1$; $2\tau_r = \theta_\beta + \theta_\gamma$,

2. BCMN - Gamma-gate setting: photopeaks

$$N_o = \frac{N_\beta N_\gamma (1 - N'_\beta \tau_\beta - N'_\gamma \tau_\gamma + N'_c \tau_{\min}) [1 - \tau_r (N'_\beta + N'_\gamma)]}{(N'_c - 2\tau_r N'_\beta N'_\gamma) (1 - N'_\beta \tau_\beta) (1 - N'_\gamma \tau_\gamma)}$$

see [7], eq. 6

(A) and (B) $\epsilon_\beta \approx 0.92$, $\epsilon_\gamma \approx 0.14$.

3. BIPM - Gamma-gate setting: threshold at 500 keV

$$N_o = \frac{N_\beta N_\gamma [1 - \tau_r (N'_\beta + N'_\gamma)]}{[N'_c - 2\tau_r N'_\beta N'_\gamma] (1 - \tau_{\min} N'_c)}$$

see [2]

(A) and (B) $\epsilon_\beta \approx 0.91$, $\epsilon_\gamma \approx 0.11$.

4. IER - Gamma-gate setting: 500 keV

$$N_o = \frac{N_\beta N_\gamma [1 - \tau_r (N'_\beta + N'_\gamma)]}{[N'_c - 2\tau_r N'_\beta N'_\gamma] (1 - \tau_{\min} N'_c)}$$

see [2]

$\epsilon_\beta \approx 0.91$, $\epsilon_\gamma \approx 0.09$.

5. LMRI - Gamma-gate setting: 1 090 to 1 420 keV

$$(A), (C), (D), (E) \quad N_o = \frac{N_\beta N_\gamma}{N_c - 2\tau_r N'_\beta N'_\gamma} \left[1 + \frac{2\tau N_c \frac{N'_{\gamma_o}}{N'_\gamma} - 2\tau_r (N'_\beta + N'_{\gamma_o})}{2 - \tau (N'_\beta + N'_{\gamma_o})} \right]$$

see [7], eq. 4
with $\tau = \tau_\beta = \tau_\gamma$.

$$\varepsilon_\beta \approx 0.91, \quad \varepsilon_\gamma \approx 0.075, \quad \varepsilon_{\gamma_o} \approx 0.30$$

N_{γ_o} is the rate of γ pulses higher than the threshold S_o in the γ channel.

$$(B) \quad N_o = \frac{N_\beta N_\gamma [1 - \tau_r (N'_\beta + N'_{\gamma_o})]}{(N_c - 2\tau_r N'_\beta N'_\gamma) \left[1 - N_c \tau \frac{N'_{\gamma_o}}{N'_\gamma} \right]} \quad \text{see [2]}$$

$$\varepsilon_\beta \approx 0.91, \quad \varepsilon_\gamma \approx 0.075 .$$

6. NPL - Gamma-gate setting: photopeaks

$$N_o = \frac{N_\beta N_\gamma (1 - N'_\beta \tau_\beta - N'_\gamma \tau_\gamma + N'_c \tau_{\min}) [1 - \tau_r (N'_\beta + N'_\gamma)]}{(N_c - 2\tau_r N'_\beta N'_\gamma) (1 - N'_\beta \tau_\beta) (1 - N'_\gamma \tau_\gamma)} \quad \text{see [7], eq. 6}$$

$$\varepsilon_\beta \approx 0.91, \quad \varepsilon_\gamma \approx 0.07 .$$

7. PTB. - Gamma-gate setting: integr al discrimination, threshold at 30 keV

$$N_o = \frac{1 + \frac{2 N'_c \tau_{\min} - 2 (N'_\beta + N'_\gamma) \tau_r}{2 - N'_\beta \tau_\beta - N'_\gamma \tau_\gamma}}{1 - 2\tau_r \frac{N'_\beta N'_\gamma}{N'_c}} \cdot \frac{N_\beta N_\gamma}{N_c} \quad \text{see [7], eq. 4}$$

$$(A), (B) \text{ and } (C) \quad \varepsilon_\beta \approx 0.91, \quad \varepsilon_\gamma \approx 0.21 .$$

8. UVVVR - Gamma-gate setting: integral discrimination, threshold at 100 keV

(A), (B), (D), (E) and (F)

$$N_o = \frac{N_\beta N_\gamma \left[1 - N'_\beta \tau_\beta - N'_\gamma \tau_\gamma + N'_c \tau_\gamma - \tau_r (N'_\beta + N'_\gamma) + w_1 + w_2 \right]}{(N'_c - 2 \tau_r \frac{N'_\beta N'_\gamma}{N'_c}) (1 - N'_\beta \tau_\beta) (1 - N'_\gamma \tau_\gamma)},$$

where

$$w_1 = \frac{\tau_\gamma N'_c}{1 - N'_\beta \tau_\beta - (N'_\gamma - N'_c) \tau_\gamma} \left[\left(1 - \frac{\tau_\gamma}{2 \tau_\beta} \right) (N'_\beta \tau_\beta - N'_c \tau_\gamma) + \frac{\tau_\gamma}{2} (N'_\gamma - N'_c) \right],$$

and

$$w_2 = 2 \frac{N'_\beta N'_\gamma}{N'_c} \rho_c \tau_r \left(\frac{\rho_c}{\rho_\beta \rho_\gamma} - 1 \right) - \tau_r \left[N'_\gamma \left(\frac{\rho_c}{\rho_\gamma} - 1 \right) + N'_\beta \left(\frac{\rho_c}{\rho_\beta} - 1 \right) \right] + \frac{\tau_r^2}{2} N'^2_\beta,$$

where

$$\rho_\beta = 1 - N'_\beta \tau_\beta,$$

$$\rho_\gamma = 1 - N'_\gamma \tau_\gamma,$$

$$\rho_c = 1 - N'_\beta \tau_\beta - (N'_\gamma - N'_c) \tau_\gamma.$$

$$(C) \quad N_o = \frac{1 + \frac{2 N'_c \tau_{\min} - 2 (N'_\beta + N'_\gamma) \tau_r}{2 - N'_\beta \tau_\beta - N'_\gamma \tau_\gamma}}{1 - 2 \tau_r \frac{N'_\beta N'_\gamma}{N'_c}} \cdot \frac{N_\beta N_\gamma}{N_c}$$

see [7], eq. 4

$$(A), (B), (C), (D), (E) \quad \varepsilon_\beta \approx 0.92, \quad \varepsilon_\gamma \approx 0.16,$$

$$(F) \quad \varepsilon_\beta \approx 0.92, \quad \varepsilon_\gamma \approx 0.21,$$

(A) - Canberra 1436 single-channel analyser,

(B) - UVVVR single-channel analyser, Gauss amplifier,

(C), (D), (E), (F) - UVVVR single-channel analyser, fast UVVVR amplifier,

(F) - multiwire proportional counter.

References

- [1] D.R. Cox and V. Isham, A bivariate point process connected with electronic counters, Proc. Roy. Soc. London A 356, 149-160 (1977)
- [2] P.J. Campion, The standardization of radioisotopes by the beta-gamma coincidence method using high efficiency detectors, Int. J. Appl. Rad. and Isotopes 4, 232-248 (1959)
- [3] A. Gandy, Mesure absolue de l'activité des radionuclides par la méthode des coïncidences bêta-gamma à l'aide de détecteurs de grande efficacité. Etude des coïncidences instrumentales, Int. J. Appl. Rad. and Isotopes 11, 75-91 (1961)
- [4] J.W. Müller, Statistiques de comptage, Rapport BIPM-77/6 (7 p.) (1977)
- [5] D. Smith, Improved correction formula for coincidence counting, submitted to Nucl. Instr. and Methods (1978)
- [6] A. Rytz, Report on the international comparison of activity measurements of a solution of ^{139}Ce (March 1976), Rapport BIPM-77/4 (70 p.) (1977)
- [7] J. Bryant, Coincidence counting corrections for dead-time loss and accidental coincidences, Int. J. Appl. Rad. and Isotopes 14, 143-151 (1963).