

Report of the CCTF WG on TWSTFT

Victor Zhang and Zhiheng Jiang

Two-Way Satellite Time and Frequency Transfer (TWSTFT)

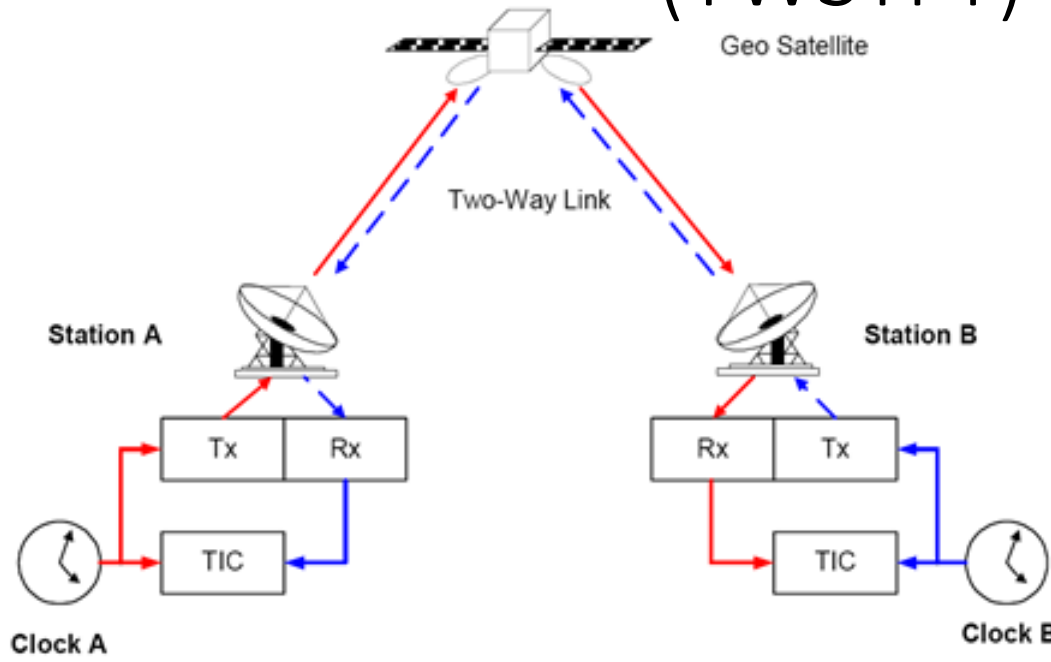

- One of the primary techniques for UTC generation
- $u_B \sim 1$ ns and $u_A \sim 0.5$ ns (Circular T)
- Accurate and precise clock comparison results available in near real time
- Independent of and complementary to GNSS time transfer

- Timing signals (phase coherent to a local clock) are carried by pseudo-random noise (PRN) codes (1 – 2.5 Mchip/s).
- Coded timing signals are exchanged between two stations in Ku-band (11-14.5 GHz) transponders (1.6 – 2.5 MHz bandwidth) on geostationary satellites.
- Each station measures the time difference of its transmit and received signals.
- Clock difference is obtained by differencing the measurements of two station with delay corrections.

TWSTFT Networks (May, 2017)

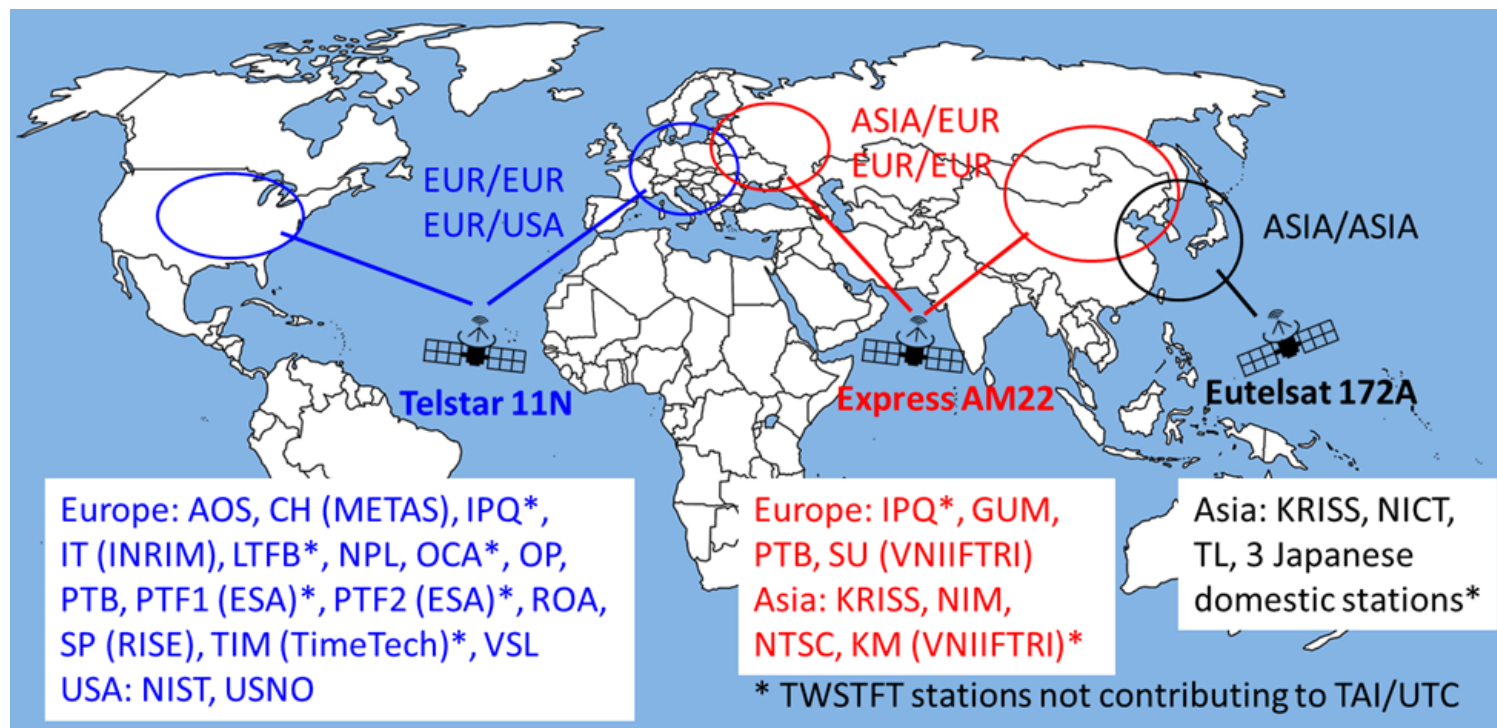

Satellite	Network	Status
Telstar 11N	Europe/Europe, Europe/USA	New contract: 11/26/2016-5/26/2021
Express AM22	Asia/Europe, Europe/Europe	Searching for a new satellite
Eutelsat 172A	Asia/Asia	Stable in near future

TWSTFT Participating Laboratories (May, 2017)

Asia: BIRMM*, KRISS, NICT, [NIM](#), NIMJ, NPLI, [NTSC](#), TL

Europe: AOS, [CH \(METAS\)](#), GUM, IPQ*, [IT \(INRIM\)](#), LTFB*, [NPL](#), OCA*, [OP](#), [PTB](#), PTF1 (ESA)*, PTF2 (ESA)*, [ROA](#), [SP \(RISE\)](#), SU (VNIIFTRI), TIM (TimeTech)*, [VSL](#)

U.S.A.: [NIST](#), [USNO](#)

[Links used in TAI/UTC computation](#)

* Participating stations have no direct links to PTB or not contributing to TAI/UTC computation

Calibrations of TWSTFT Links

Calibration campaigns during 2015 – 2017:

- 2015 BIPM GNSS receiver: NIST, OP, PTB, USNO **with Triangle Closure Calibrations to CH, IT, ROA, SP and VSL (TM268)**
- 2016 TimeTech mobile station: IT, OP, PTB ROA, SP
- 2016 USNO X-band mobile station: PTB, USNO
- **2016-2017 USNO Ku-band mobile station: NIST, USNO**

The “TWSTFT Calibration Guidelines for UTC Time Links” was updated in 2016

UTC link calibrations

Non-UTC link calibrations

Activity (1): Task Group Study on Long-Term Instability of UTC Time Links

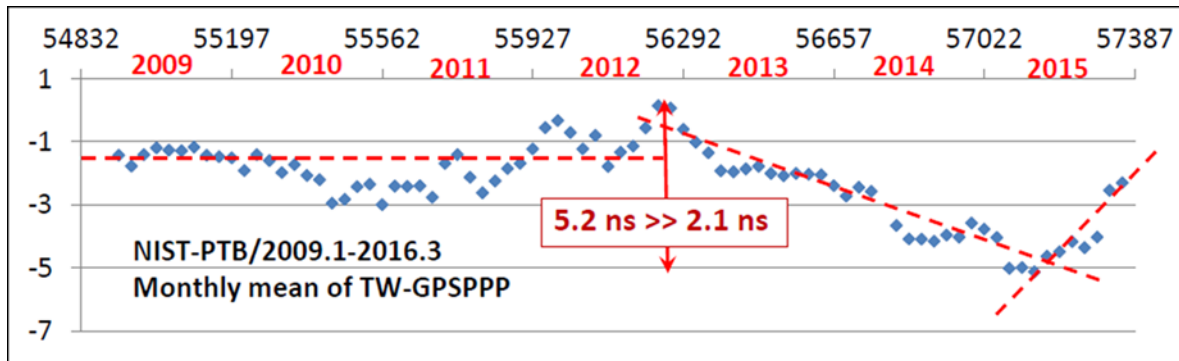

Seven-year Double-Clock Difference (DCD) of TWSTFT – GPSPPP for the NIST/PTB baseline. The vertical axis is for DCD in ns, and the horizontal axis is for MJD in days. The estimated uncertainty of the NIST/PTB link was 2.1 ns during the data period.

- several-ns variations happen too often to ignore; they are observed in GNSS-only, TWSTFT-only, and GNSS-TWSTFT;
- past performance is not a reliable indicator of future stability;
- multiple independent GNSS systems are crucial;
- calibrations should be conducted yearly, a GNSS calibration can be complementary to a TWSTFT calibration, especially if they are done at the same time;
- environmental control is important;
- more attention must be given to recording configuration changes and environmental conditions.



Recommendation “On Utilizing and Monitoring of the Redundant Time Transfer Equipment in Timing Laboratories Contributing to UTC”

Activity (2): Pilot Study on Using Software Defined Radio (SDR) Receivers for TWSTFT

SDR TWSTFT receivers are used to measure the coded timing signals transmitted by the currently used TWSTFT equipment.

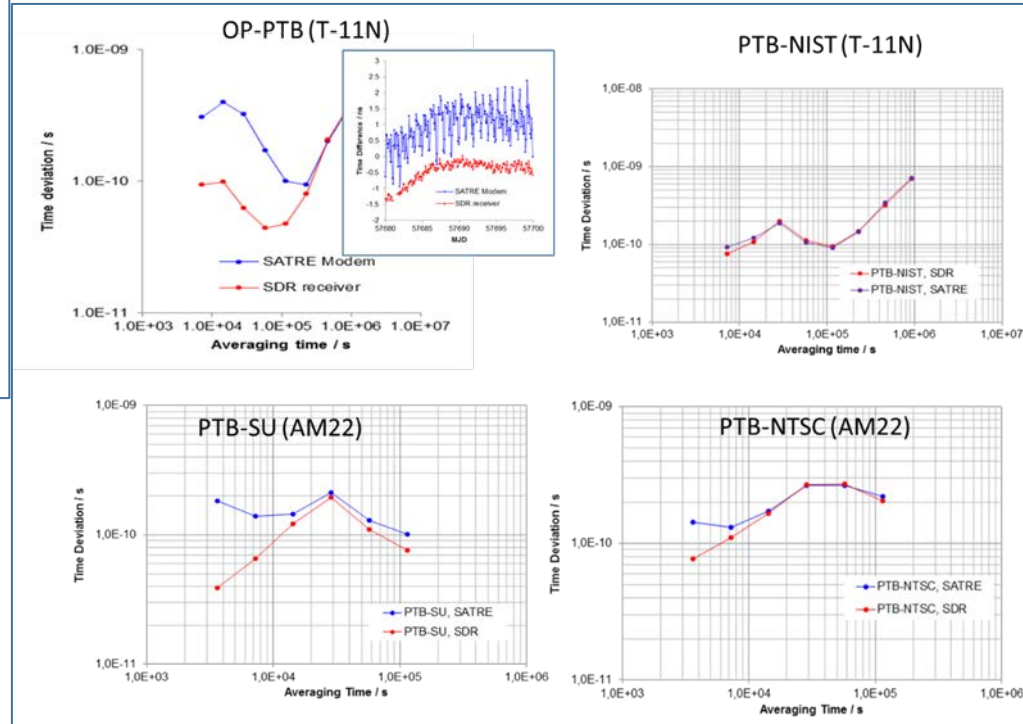
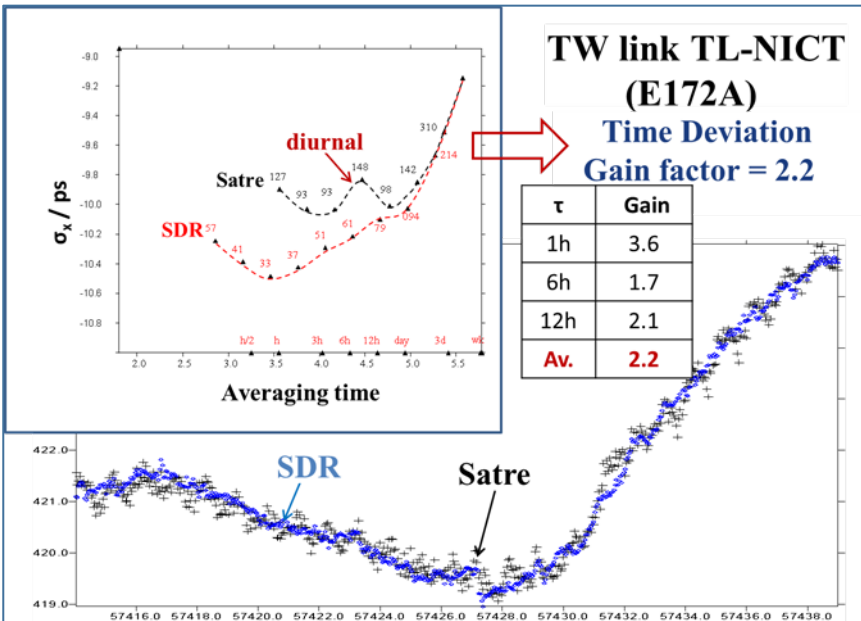

SDR TWSTFT shows

- significant reduction of diurnal and time transfer noise for most *inner-continental* TWSTFT links;
- Reduction of short-term (a few hours) time transfer noise for *inter-continental* TWSTFT links.

Activity (3): Study on Using Redundant TWSTFT Measurements

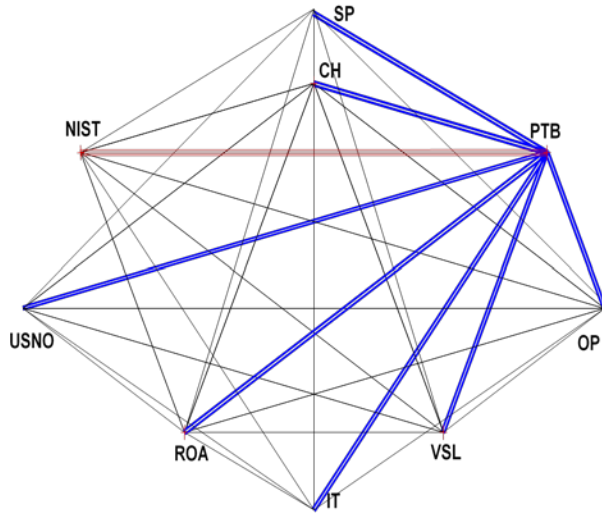

Example of computing OP/PTB TWSTFT difference from the NIST/OP – NIST/PTB indirect (redundant) measurements

The indirect link TWSTFT does not require additional measurements or new equipment.

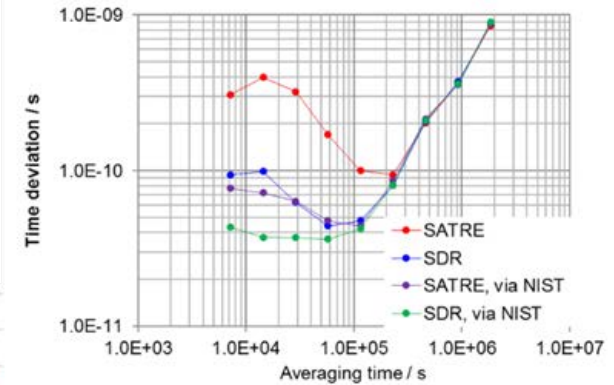

The UTC time links (blue or red lines) and the redundant/non-UTC links (black lines)
 The blue links are calibrated with the TW mobile station ($\mu\text{B} \leq 1 \text{ ns}$) and red links with the GPS calibrator ($\mu\text{B} \leq 1.5 \text{ ns}$)

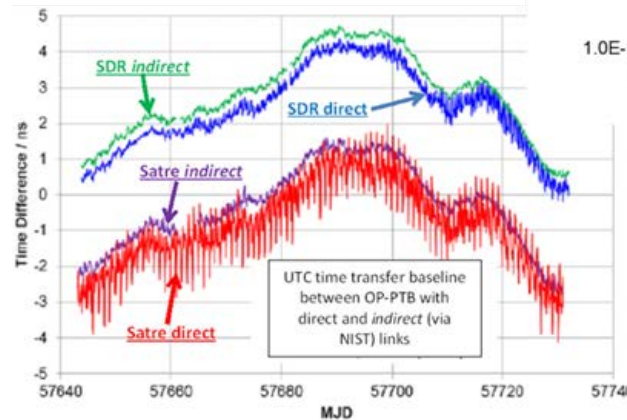

Time transfer noise and diurnal in the direct inner-Europe TWSTFT links can be reduced by using the indirect links via the transatlantic TWSTFT measurements.

Activity (4): Developing Digital TWSTFT Modem

Carrier phase@12.75 GHz,

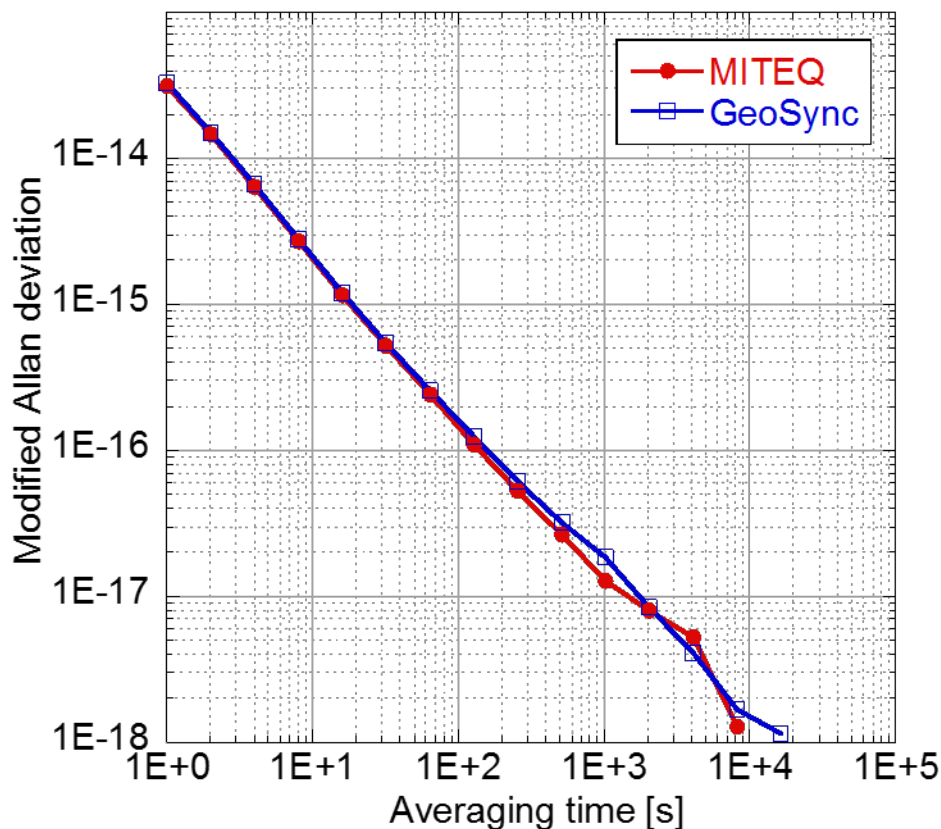

Common clock measurement setup

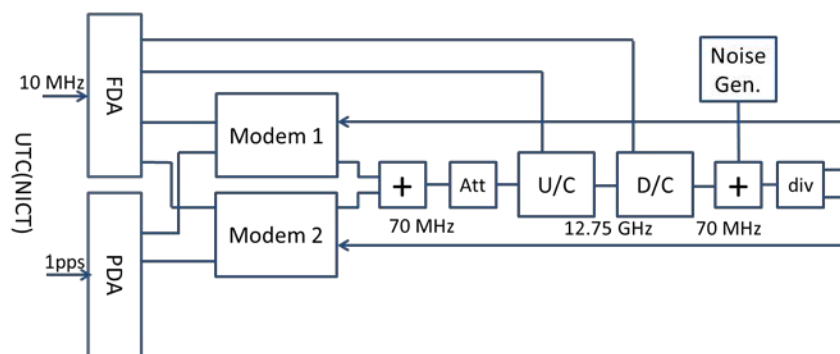

If the carrier-phase performance can be realized through the satellite TW, it has the potential to directly compare remote optical frequency standards.

Activity (5): Meetings

Annual meetings:

- 24th Meeting, 7-8 September, 2016, NIST, Boulder, Colorado, U.S.A.
- 25th Meeting, 18-19 May, 2017, NTSC, Xi'an, China

Participating stations meetings at conferences:

- PTTI 2016, 25-28 January, 2016, Monterey, California, U.S.A.
- 30th EFTF, 4-7 April, 2016, York, United Kingdom
- PTTI 2017, 30 January – 2 February, 2017, Monterey, California, U.S.A.

Thanks for the supports from TWSTFT
participating laboratories, the BIPM
and CCTF members!

CCTF WG on TWSTFT